



العين RACEWAY

ROTAX®

AUTHORISED DISTRIBUTOR
KARTING



ROTAX® RACING



#MOJO®

VEGA

XPS

RD1 ELITE



UAE ROTAX MAX CHALLENGE 2024-25

Organised by AL AIN RACEWAY KART CLUB

In Association With



SERIES SPORTING REGULATIONS

VERSION 09.08.24

REGULATIONS

The final text of these Sporting Regulations shall be the English version, which will be used should any dispute arise as to their interpretation. Headings in this document are for ease of reference only and do not form part of the regulations.

1 – GENERAL

The Series and its events shall be run in accordance with the requirements of EMSO using the EMSO National Sporting Code, EMSO Code of Conduct, EMSO Environmental Code, the UAE RMC Technical Regulations 2024/25, these Sporting Regulations, the Supplementary Regulations of each Event of the Series, official Bulletins and incorporating specific elements from the FIA International Sporting Code (ISC) and its appendices, FIA Karting General Prescriptions and FIA Karting Specific Prescriptions, referred herein.

All the parties concerned (EMSO, Al Ain Raceway, Al Forsan International Sports Resort, Dubai Kartdrome, Muscat Speedway, Yas Marina Circuit and entrants) undertake to apply and observe the rules governing these race events.

ANYTHING WHICH IS NOT EXPRESSLY ALLOWED IS FORBIDDEN.

2 – INFORMATION SPECIFIC TO THE CHAMPIONSHIP

2.1 ORGANISER

Al Ain Raceway Kart Club (AARKC)

Al Ain Raceway

P.O. Box 85393

Al Ain, UAE

Phone: +971 (0) 3 768 6662

E-mail: admin@alainraceway.com

Web: www.alainraceway.com/uaermc/

✉ P.O.Box 85393. Al Ain. UAE.

☎ +971 (0) 3 768 6662

@ info@alainraceway.com

🌐 www.alainraceway.com

2.2 - DATES / EVENTS

R1.1:	12 OCT 2024	AL AIN RACEWAY
R1.2:	13 OCT 2024	AL AIN RACEWAY
R2:	03 NOV 2024	DUBAI KARTDROME
R3:	07-08 DEC 2024	MUSCAT SPEEDWAY
R4:	18-19 JAN 2025	DUBAI KARTDROME (FORMAT B)
R5.1:	08 FEB 2025	YAS MARINA CIRCUIT *
R5.2:	09 FEB 2025	YAS MARINA CIRCUIT *
R6:	23 FEB 2025	AL FORSAN INTERNATIONAL SPORTS RESORT *
R7:	15-16 MAR 2025	AL AIN RACEWAY *
R8.1:	05 APR 2025	AL AIN RACEWAY *
R8.2:	06 APR 2025	AL AIN RACEWAY *

* ABU DHABI SPORTS COUNCIL CHALLENGE TROPHY EVENT – SEE ALSO ARTICLE 2.7.9

2.3 - PROVISIONAL INFORMATION OF THE MEETING

This is according to each circuit licence and event permit, sanctioned by EMSO (ASN). Additional information will be available in the Supplementary Regulations for each meeting. A detailed time schedule for each event will be issued in advance and displayed on the official Notice Board.

Kart owner test sessions are not part of the UAE RMC Championship. Competitors must contact the circuits directly for information on availability and pricing. See also Article 10.

2.4 - ENTRIES:

2.4.1 - Reception Office

Al Ain Raceway Kart Club (AARKC)
P.O. Box 85393
Al Ain, UAE
Phone: +971 (0) 3 768 6662
E-mail: admin@alainraceway.com

2.4.2 - Deadlines:

As per articles 2.2, 2.3, the Supplementary Regulations and Schedule of each event, a correctly completed Entry submission must be received 14 days **before** the race meeting date. The Organisers reserve the right to refuse entries submitted after this deadline.

2.4.3 - Receipt:

Any entry not accompanied by the total fees shall be null and void (see 2.4.5).

2.4.4 - Restriction:

Maximum entries apply in all classes. Entry will be accepted in the order of receipt of the entries. **Entry to Round 8 will be evaluated by the organisation if the competitor concerned has not competed in any previous championship rounds. Championship points will not be awarded to drivers permitted to enter the final round only.**

2.4.5 – Fees:

2.4.5.1 – Race Fee:

OPTION 1 – PREPAID ENTRY + TYRES FOR THE ENTIRE SERIES

CLASS	'EARLY BIRD' PAY 31 AUG 2024			ADVANCE INSTALMENT 30 SEP/31 OCT/30 NOV 2024		
	TOTAL	SAVING		TOTAL	SAVING	
MICRO MAX	15895	6165	30%	17900	4160	20%
MINI MAX	15895	6165	30%	17900	4160	20%
JMAX	17985	6275	30%	19990	4270	20%
MAX	17985	6825	30%	19990	4820	20%
DD2/MASTER	17985	6825	30%	19990	4820	20%

'EARLY BIRD' and 'ADVANCE INSTALMENT' totals include Basic Membership Fee PLUS Race Entry Fees for all events as detailed in Article 2.2 PLUS 11 set of tyres to cover all events.

Deadline for 'EARLY BIRD' payment is **31st August 2024**.

Deadline for 'ADVANCE INSTALMENT' payments are **30th September (AED 7000), 31st October (AED 7000), 30th November 2024 (balance payment)**.

All payments are non-transferable and non-refundable.

To include Premium Membership (see UAE RMC membership form) add AED 745 to the respective total.

OPTION 2 – PREPAID ENTRY FEES FOR THE ENTIRE SERIES

CLASS	'EARLY BIRD' PAY 31 AUG 2024			ADVANCE INSTALMENT		
	TOTAL	SAVING		TOTAL	SAVING	
ALL ROTAX	8965	3745	30%	N/A	N/A	N/A

'EARLY BIRD' and 'ADVANCE' totals include Basic Membership PLUS Race Entry Fees for all events as detailed in Article 2.2. Deadline for 'EARLY BIRD' payment is **31st August 2024**.

All payments are non-transferable and non-refundable.

To include Premium Membership (see UAE RMC membership form) add AED 745 to the respective total.

OPTION 3 – PAY AS YOU GO

- Basic Membership Fee AED 525
- Premium Membership Fee AED 1270
- Race Entry Fee R1.1, R1.2, R7, R8.1, R8.2 AED 840
- Race Entry Fee R2 AED 1295
- Race Entry Fee R3 AED 1250
- Race Entry Fee R4 AED 1950
- Race Entry Fee R5.1, R5.2 AED 1195
- Race Entry Fee R6 AED 1100
- Late Entry Supplement (within 2 weeks of event) AED 210

Entry Fee automatically discounted until the 2 week entry deadline

See UAE RMC Membership Form for details on Premium Membership benefits

2.4.5.2 – Supplementary Fees (optional):

- Transponder hire (per weekend) AED 210
- Tyres Micro MAX and Mini MAX (per set) AED 850
- Tyres Junior MAX (per set) AED 1050
- Tyres MAX and DD2 (per set) AED 1100
- Tyre fitting (per set) AED 105
- HQ Photos AED 210

Please note that these are preferential tyre prices for pre-ordered tyres paid for as part of the 'pay as you go' option (see 2.4.5.1). Tyres purchased on race day will be subject to availability and charged at premium rates equal to the above amounts plus AED 100 per set (see 4.1).

2.4.6 – Payments:

Payments should be made (in full according to 2.4.2, 2.4.3 and 2.4.5) in cash or cheque, or by direct transfer to:

Account Name	Al Ain Raceway
Bank Name	Abu Dhabi Islamic Bank
Bank Address	AL BATEEN Br, Abu Dhabi, U.A.E
Account Number	1-291975-2
IBAN #	AE-13-050-0000 0000 12919752
BIC/SWIFT CODE	ABDIAEAD

2.5 – COMPETITION REQUIREMENTS:

2.5.1 – Kart Licence:

A. Drivers must be in possession of a valid National or International Kart Licence issued either by EMSO or the ASN of another country. If the Entrant is other than the driver then the entrant must hold a separate valid Entrant Licence issued by EMSO or the ASN of another country.

B. All competitors holding a licence issued outside UAE must gain "Start Permission" from their licence-issuing ASN. All physical competition licences must be surrendered at signing on (along with the start permission paperwork if applicable) for verification. Failure to produce the required documentation will result in enforced non-participation.

C. Competitors from outside UAE holding a valid National or International Kart Licence issued by a recognised ASN as described in 2.5.1.A may compete and score Championship points within the UAE RMC Championship and will also be considered for ADSC Challenge awards.

D. Only drivers holding a National or International Kart Licence issued by a recognised ASN of a country within the MENA zone are eligible to qualify for the Rotax MAX Challenge Grand Finals, subject to final approval from EMSO.

E. Any applications received that apply to C must apply in advance to both EMSO and Al Ain Raceway Kart Club for starting approval and, if approved, must gain the required "Start Permission" from their licence-issuing ASN.

2.5.2 – Visa:

Entrants and drivers wishing to take part in any International Competition organised abroad can only do so with the approval of the EMSO. This authorisation shall be given in such form as they might deem appropriate.

For International Events, all drivers (or parents/guardian/team in case of drivers under 18yrs) must be in possession of a valid Entrants Licence. Further, the minimum licence requirement is Kart International with a valid medical.

2.6 – RACE MEETING FORMATS:

Each race meeting will consist of ONE of the following formats unless otherwise indicated in the Event Supplementary Regulations or by means of a Bulletin:

FORMAT A – STANDARD

- Signing on
- Scrutineering
- Driver's Briefing
- Practice/Qualifying
- Heat
- Pre-Final
- Final
- Award presentation

FORMAT B – EXTENDED

- Signing on
- Scrutineering
- Driver's Briefing
- Practice/Qualifying
- 3 x Heats
- Pre-Final
- Final
- Award presentation

2.6.1 – Signing on:

Signing on will commence at the beginning of the event at the time stipulated in the event Schedule and/or Supplementary Regulations.

Drivers must present their valid racing licence, all associated paperwork and their personal timing transponder to be verified by the administration team before being allowed to sign on. Drivers who are unable to produce a valid licence, or proof thereof, will be referred to the Stewards and may not be permitted to take part in the race meeting.

The event Organiser and the Stewards will control all licences during the event.

For drivers under 18 years, a countersignature is required from a parent or legal guardian. If a parent is not available to sign he/she must authorise another individual (over 18yrs) to act as the legally responsible adult by obtaining the relevant paperwork IN ADVANCE and submitting it to the organisation as part of the race entry.

Additionally, and optionally, a representative (entrant) may be nominated to accompany the driver at briefings and judicial hearings instead of the parent (see Article 14.1). This individual MUST also submit their signature at signing on and MUST attend the Driver's Briefing.

2.6.2 – Scrutineering:

Scrutineering will take place in a predetermined area and at the time specified in the event Schedule and/or Supplementary Regulations.

Drivers must first complete a 'Scrutineering Card' and present themselves along with their race wear and kart (which must be ready to race including racing numbers and sponsor stickers) to the Scrutineers at the allotted time for a basic safety inspection.

The Scrutineering Card will be retained by the Scrutineers throughout the event and referred to as needed. The competitor is solely responsible for ensuring that the information on this card is correct.

Drivers who do not successfully pass Scrutineering will not be permitted to take part in the race meeting. A driver shall not be allowed to change his/her equipment after it has been identified at Scrutineering without the express permission of the Scrutineers.

Note: Post-race scrutineering will be conducted at the discretion of the Chief Scrutineer in conjunction with other Senior Race Officials. Drivers are solely responsible for the technical compliance of their kart, engine and race wear at the time of inspection.

WHERE REGISTRATION AND SCRUTINEERING IS AVAILABLE THE DAY BEFORE RACE DAY, ALL DRIVERS ATTENDING PRACTICE SESSIONS ON THESE DAYS MUST SIGN ON AND/OR SCRUTINEER AS EARLY AS POSSIBLE DURING THIS SPECIFIED WINDOW.

THE ORGANISERS RESERVE THE RIGHT TO PREVENT DRIVERS/TEAMS FROM TAKING PART IN PRACTICE UNTIL THEY HAVE COMPLETED SCRUTINEERING.

RACE DAY REGISTRATION AND SCRUTINEERING ARE RESERVED FOR THOSE UNABLE TO ATTEND THE CIRCUIT PRIOR TO RACE DAY.

2.6.3 – Drivers' Briefing:

The Entrants' and Drivers' Briefing is either an official digital presentation and/or a meeting organised by the Clerk of the Course for all Entrants and Drivers entered in the event. The presence of all drivers and drivers' representatives (as dictated by the signing on paperwork) is mandatory throughout the Briefing under pain of a sanction or even of a possible disqualification from the event. Attendance will be monitored and recorded. Competitors **MUST** present their unique Driver ID badge (issued at their first event of the season) to be scanned by the race administration. Drivers failing to do so will be referred to the Stewards for action.

For Team Entrants Licences (not individual), the team should put forward a maximum of 3 official team personnel to be registered with the organisation under 'Entrant' during the season. For any given event, only Entrants attending the Driver's Briefing will be permitted to accompany drivers to the Stewards of the Meeting.

The aim of the Briefing is to remind Entrants and Drivers of points concerning safety and organisation, whether general or specific, and to provide clarification concerning the interpretation of the regulations.

The time of the Briefing is specified in the event Schedule as well as the Supplementary Regulations. Extra meetings may be organised if this is deemed necessary.

2.6.4 – Practice/Qualifying Session:

The length of this session will be stipulated in the event Supplementary Regulations.

All competitors must leave the Pre-Grid at the time of the green flag and complete a series of timed laps. Once a driver enters the Pit Lane their session is deemed to be over.

The result of this session will determine the starting positions for the Heat(s) in terms of the average lap time classification of the best 3 laps of the session (see also 2.6.5). In the case of 2 drivers achieving identical averages, the classification will revert to the fastest single lap time set by each individual in order to determine priority, and so on (see also 3.8).

Failure to participate could lead to disqualification from the meeting. Drivers failing to complete at least 3 timed laps will be classified behind all drivers completing at least 3 timed laps. Drivers failing to complete at least one timed lap may be referred to the Stewards.

2.6.5 – Superpole (optional):

At selected events and for classes where the number of entries justifies it, only the top ranked drivers in Qualifying may be selected to compete in a 1 lap shoot-out.

Drivers will be released onto the circuit at regular intervals to begin a warm-up lap. The order of release will be the reverse of the Qualifying session ranking, with Pole Position last to be released.

A green flag displayed at the start line will signal the start of the Superpole lap.

A chequered flag will signal the end of the Superpole lap.

Drivers must ensure that they do not impede their fellow competitors on either the warm-up lap or the Superpole lap. Failure to do so will incur grid place penalties.

Superpole participants will be ranked according to their respective Superpole lap times which will accordingly determine their Heat starting positions, irrespective of their performances during Qualifying. If 2 drivers achieve identical Superpole times, Organisers will revert to the respective Qualifying classification to determine priority.

2.6.6 – Heat(s):

The length of this race (in laps) will be specified in the event Supplementary Regulations. The winner of the Heat is the driver completing the stipulated quantity of laps in the shortest time. All drivers crossing the start/finish line behind him/her will be deemed to have finished the race regardless of the number of laps they have completed.

Drivers completing the same number of laps will be classified in the order in which they cross the finish line. The results of the Heat(s) will determine starting positions for the Pre-Final (see 2.6.12 and also 3.8).

2.6.7 – Pre-Final:

The length of this race (laps) will be specified in the event Supplementary Regulations.

The winner of the Pre-Final is the driver completing the stipulated quantity of laps in the shortest time. All drivers crossing the start/finish line behind him/her will be deemed to have finished the race regardless of the number of laps they have completed.

Drivers completing the same number of laps will be classified in the order in which they cross the finish line.

The results of the Pre-Final will determine the starting positions for the Final (see 2.6.12).

2.6.8 – Final:

The length of this race (laps) will be specified in the event Supplementary Regulations. The winner of the Final is the driver completing the stipulated quantity of laps in the shortest time. All drivers crossing the start/finish line behind him/her will be deemed to have finished the race regardless of the number of laps they have completed. Drivers completing the same number of laps will be classified in the order in which they cross the finish line.

2.6.9 – Did Not Start (DNS):

DNS is used to classify any driver who fails to cross the start line at the time of the start signal, having been present with his/her kart on the grid within the time limit. See 2.7.4.

2.6.10 – Did Not Finish (DNF):

DNF is used to describe any driver who fails to cross the finish line to receive the chequered flag. In this case, drivers will be classified in the order of the number of laps completed. See 2.7.5. Drivers completing the same number of laps will be classified in the order in which they last crossed the finish line.

2.6.11 – Award Presentation:

Trophies will be presented to the top drivers in each class according to the official finishing positions in the Final. The number of trophies awarded will depend on the total number of class entrants according to the following:

1-3 competitors	1 st place only
4-6 competitors	1 st and 2 nd place only
7+ competitors	1 st , 2 nd and 3 rd places

Results do not become official until 30 minutes "protest time" has elapsed without objection. Prize winners are to ensure that race suits are worn and zipped up with collar closed. Race boots should also be worn. See also section 8.

2.6.12 – Alternative Format for Large Subscriptions:

In cases where the total number of accepted class subscriptions exceeds the circuit maximum (according to the specific circuit homologation), competitors will be grouped according to overall Qualifying ranking. Under Format A, competitors will then race in two Heats (instead of one Heat and one Pre-Final) to attempt to qualify for the Final.

After the Heats, the top ranked drivers will automatically qualify for the Final. Remaining drivers will either play no further part in the event or, in exceptional cases where a B Final is scheduled, may have the chance to repechage to the Final. The Clerk of the Course will explain this at the Driver's Briefing.

In Format B, drivers will be split into groups after Qualifying and will each compete in 3 Heats followed by a Pre-Final to attempt to qualify for the Final.

2.7 – POINT SCORING:

Overall Score:

Championship points are awarded for Qualifying, Heat, Pre-Final and Final placings only (see 2.7.1, 2.7.2 and 2.7.3).

Selected rounds will utilise Format B, incorporating 3 Heats, 1 Pre-Final and 1 Final.

In the case of 2 or more drivers finishing the season with the same number of points, the higher place in the Championship will be awarded to the driver with the greatest number of 1st places in Finals. If the number of 1st places is equal then the greatest number of 2nd places will be used, and so on until a winner emerges.

If this procedure fails to produce a result, AARKC Committee will nominate a winner according to such criteria as it deems fit.

At the conclusion of the season, each driver must drop his/her worst 5 race scores (Heat, Pre-Final or Final) to determine an ultimate Championship total. This includes non-attended rounds. Qualifying points are not eligible for deduction.

In case a Heat, Pre-Final or Final is cancelled because of "force majeure," no points will be awarded and this becomes ineligible for deduction.

Any race in which a point penalty is incurred by disqualification or exclusion is not eligible for deduction. Please note that a black flag does not necessarily denote disqualification.

2.7.1 – Qualifying Points:

Only the top 5 ranked Qualifiers score Championship points, as detailed below:

1 st place	10 points
2 nd place	08 points
3 rd place	06 points
4 th place	04 points
5 th place	02 points

2.7.2 – Heat and Pre-Final Points:

Championship points are awarded as follows:

1 st place	30 points
2 nd place	27 points
3 rd place	25 points
4 th place	24 points
5 th place	23 points ...and so on down to the last place finisher.

2.7.3 – Final Points:

Championship points are awarded as follows:

1 st place	40 points
2 nd place	35 points
3 rd place	32 points
4 th place	30 points
5 th place	29 points
6 th place	28 points ...and so on down to the last place finisher.

2.7.4 – Did Not Start (DNS):

For each race (Heat, Pre-Final and Final) the number of championship points awarded equates to 5 points less than the last classified finisher, down to a minimum of zero points (see also 2.6.9).

2.7.5 – Non-finish (DNF):

In the case of a DNF in any championship-point-scoring race, the number of points awarded will be determined by the driver's classified position (see also 2.6.10).

2.7.6 – Penalties:

Drivers receiving a black flag may be subject to further penalties including, but not limited to, point deductions and fines (see also Articles 12 and 13).

If the black flag is due to cheating or deemed by officials to be an intentional breach of rules, any points awarded for that race will be deducted from the overall score (minus points). Penalties will apply under ISC Article 12.4 – Scale of Penalties.

2.7.7 – Bonus Points:

At the conclusion of the season 30 bonus points will be awarded to each driver entering and competing (to the satisfaction of the Stewards) at every one of the series' events. Competitors missing an event due to a legitimate medical issue (as evidenced by submission of medical certificate from an approved body) will be eligible for bonus points.

2.7.8 – Point Allocation for 'Masters' Drivers:

DD2 and DD2 Master competitors share the same grid and overall points are awarded according to the points system explained above.

Drivers meeting 'DD2 Master' requirements (see Section 3 – Classes and Eligibility) will also take their respective point totals into a separate DD2 Master Championship table. For example, a DD2 Master driver finishing a Final in 3rd place overall will receive 32 points in the overall DD2 classification and also carry this 32 points into the DD2 Master Championship with all other DD2 Master drivers.

2.7.9 – Abu Dhabi Sports Council Challenge Trophy (ADSCCT):

The ADSCCT is a separate 'Club' Championship, running as part of the UAE RMC but consisting of 6 rounds according to Article 2.2.

Points will be accrued as per the UAE RMC Championship points systems described above (Article 2.7) with all 6 events counting towards a final ADSCCT total.

At the end of the season, awards will be presented to the top 3 drivers in the ADSCCT standings in each category. Competitors finishing 1st, 2nd or 3rd in the overall UAE RMC Championship are ineligible for ADSCCT awards.

2.7.9.1 – Abu Dhabi Sports Council Challenge Trophy Advance Fees

Standard UAE RMC Race Entry Fees apply to all ADSCCT rounds (Article 2.4.5.1 Option 3 and 2.4.6) but advance payment discounts for all 6 AARCT events are shown below. [Additional rounds of the UAE RMC can be entered at the discretion of the competitor.]

OPTION 1 – PREPAID ENTRY + TYRES FOR THE 6-ROUND SERIES

CLASS	ADVANCE PAY 19/01/25		
	TOTAL	SAVING	
MICRO/MINI MAX	9425	2210	20%
JUNIOR MAX / MAX	10565	2270	20%
DD2/MASTER	10565	2570	20%

'ADVANCE' totals include Basic Membership Fee PLUS Race Entry Fee (6 rounds) PLUS 1 set of tyres per round (6 sets total).

Deadline for 'ADVANCE' payment is **19th January 2025**.

All payments are non-transferable and non-refundable.

To include Premium Membership (see UAE RMC membership form) add AED 745 to the respective total.

OPTION 2 – PREPAID ENTRY FOR THE 6-ROUND SERIES

CLASS	ADVANCE PAY 19/01/25		
	TOTAL	SAVING	
ALL ROTAX	5225	1310	20%

'ADVANCE' total includes Basic Membership PLUS Race Entry Fees (6 rounds).

Deadline for 'ADVANCE' payment is **19th January 2025**.

All payments are non-transferable and non-refundable.

To include Premium Membership (see UAE RMC membership form) add AED 745 to the respective total.

2.7.10 – Team Points:

Teams will carry any points (2.7.2 & 2.7.3) awarded to their [single] top-ranked driver per race in each class (Article 3) into a separate points ranking system to determine the top ranked Team at each event.

In order to be considered for team points drivers must confirm their team representation to the race administration so that their performances can be associated with their chosen team and reflected in the official results.

2.8 – STARTING PROCEDURES:

2.8.1 – General:

Starts may be either 'standing' or 'rolling'. The regulations for "Rolling starts for direct drive karts with or without clutches" or "Standing starts for karts with gearboxes" of the FIA Karting General Prescriptions will apply accordingly.

Kart trolleys will not be permitted onto the circuit from the moment the karts leave the Grid to the time all running karts have returned to the pits following the chequered flag.

2.8.2 – Starting Grid:

Karts shall be lined up on the Pre-Grid as detailed in section 2.6. It is the driver's responsibility to ensure that both he/she and their kart are in position on the Pre-Grid before the Pre-Grid closes. Any drivers arriving after this time will not be permitted to enter the circuit without the express permission of the Clerk of the Course.

Only one helper (mechanic) is permitted to accompany the driver/kart onto the Pre-Grid. Other than that, the Pre-Grid is out of bounds to all personnel who are not operating in an authorised capacity as signed-on Officials.

Karts placed on the Pre-Grid must be ready to race. It is strictly forbidden to carry out any work and/or set-up on the kart on the Pre-grid with the exception of tyre pressures, which can be adjusted by the driver or his/her mechanic using his/her own tyre pressure gauge by letting air out only.

Anyone wishing to carry out work after the kart has been placed on the Pre-Grid must completely remove the kart beyond the last placed kart on the Pre-Grid, or to a place designated by the Grid Marshal or detailed in the Briefing, before carrying out such work.

Mechanics must clear the Pre-Grid 1 min before the start of the Race ("1 minute" board).

30-seconds after the "30 seconds" board is displayed the green flag will be shown at the front of the grid to indicate that the karts must proceed onto the circuit to either commence Practice/Qualifying or to begin a Formation Lap.

Should a driver require assistance after the "30 seconds" signal (or when the green flag is shown), a mechanic may only work on the kart once the other karts have left the Pre-Grid.

If a driver is unable to start from the Pre-Grid at the time of the green flag, he/she will only be authorised to join the circuit on the orders of the Clerk of the Course and will take the start from the back of the formation, irrespective of the number of Formation Laps.

2.8.3 – Formation Lap:

Drivers should leave the Pre-Grid when the green flag is displayed.

The field must stick together in 2 distinct lanes as per the positions on the Pre-Grid. It is the responsibility of the driver in Pole Position to set the pace, which should be steady and controlled. The driver in 2nd position should remain alongside during this lap.

Drivers must not break formation before taking the start (see 2.8.4). Erratic weaving (zig-zags) is prohibited. Offending drivers will be penalised.

There is only one Formation Lap unless otherwise indicated during the Briefing.

If a driver stops for any reason during the Formation Lap and the kart cannot be restarted quickly, it must be immediately removed from the track to a place of safety.

A driver who is delayed and finds themselves out of position will have the possibility of regaining his/her place (1) only if this manoeuvre does not impede other drivers and (2) in all cases before having reached the Red Line which will be marked on the track and indicated by the Clerk of the Course during the Briefing.

In order to regain one's position, it is forbidden to use any course other than the track used during the race. After the red line overtaking is forbidden until the start signal is given.

Aside from legitimately regaining a starting position, it is forbidden to overtake another driver under pain of a penalty inflicted by the Stewards (typically 10 seconds for first [single] offence).

If he considers that a driver has been immobilised as a result of another driver's mistake, the Clerk of the Course may stop the Formation Lap and recommence the Starting Procedure on the basis of the original grid or allow the impeded driver to regain his/her position.

Any driver permitted to join the track AFTER the initial green flag or after a false start MUST remain at the back of the grid on the current formation lap and any subsequent formation lap until the race is officially started. See also 2.8.5.

It is the responsibility of Pole Position to keep the field at a reduced and constant speed from the red line up until the tramlines in the interests of safety. Anti-Pole must ensure that he/she is not ahead of Pole Position at the time the start signal is given.

DD2 competitors should remain fixed in 1st gear from the red line up until the start signal is given.

In the case of repeated false starts or of incidents during the Formation Lap(s), the Clerk of the Course, acting as a Judge of Fact, may stop the starting procedure by means of the red flag and inform the Stewards, who will be entitled to inflict on the offending Drivers a penalty according to Article 2.24 of the FIA Karting General Prescriptions.

Additional Formation Laps required due to aborted starts may be deducted from the race distance at the discretion of the Clerk of the Course.

2.8.4 – Race Start (Rolling):

At the end of the Formation Lap, drivers will proceed forward in two lines at a reduced and constant speed towards the Starting Line, as dictated by the front row. Each line of karts shall remain within its respective corridor (tramlines) marked on the track.

A driver crossing the tramlines [before the start signal is given] is liable to be sanctioned by the Stewards on the basis of a time penalty of 3 seconds for partially crossing the lines and 5 seconds for completely leaving the corridor.

When the karts approach the Start Line the red lights will be on. Karts must maintain their position until the start signal is given.

If he/she is satisfied with the formation, the Starter will give the start by switching off the red lights. If he/she is not satisfied with the procedure flashing amber lights will be activated (with the red lights) to indicate a "no-start", meaning that an extra Formation Lap will take place. If the reason for a "no-start" is due to a particular offender, Officials may decide to impose a penalty at their discretion.

In the case of start light failure, the National flag will be used. The flag will be held out stationary on the approach and raised to indicate a start.

As soon as the start signal has been given racing conditions are applied.

The Clerk of the Course assumes responsibility for determining the safest way to deal with stranded karts/drivers once the race is live. Under his direction the marshals will sometimes assist driver(s) to a place of safety before transferring the kart(s) to a safe position although it should be noted that this is the driver's responsibility. Alternatively, in certain circumstances he may (in the interests of safety) direct that karts are separated/manoeuvred so that the drivers can continue. Only registered officials may assist.

2.8.5 – False Start:

A false start will be indicated by one or both of the following:

- A flashing amber "first corner light"
- A false start flag (green with yellow chevron) displayed after the Start Line

In either of these circumstances, competitors are expected to raise one arm in acknowledgement of the false start before slowing and organising themselves into their original starting positions to attempt a restart at the next opportunity.

Any competitors forced to take the [false] start out of position following a pre-grid or formation lap delay may not assume their original grid position. Drivers permitted to join the grid AFTER a false start **MUST** remain at the back of the field until the race is officially started.

2.8.6 – Jump Start:

Any attempts to jump the start or delay it and any karts leaving the lane (rolling start) or grid slot (standing start) before the lights are switched off shall be sanctioned according to Article 13B (in line with Article 2.24 of the FIA Karting General Prescriptions).

2.9 – RACE NEUTRALISATION (FULL COURSE YELLOW):

The Clerk of the Course may decide to 'neutralise' a Race or Qualifying session by directing that a *full course yellow* be issued. This procedure can be used where the track is obstructed and/or drivers and officials are in immediate physical danger BUT the circumstances are insufficient to justify a stoppage (see Article 2.10).

Simultaneously, yellow/black quartered flags will be shown at all Marshals' Posts, accompanied by a 'SLOW' board where available. Yellow warning lights will be activated at circuits with this capability. The race leader's number will be displayed at the start line. [At venues where yellow/black flags are unavailable, **stationary** yellow flags will be used.]

The leading kart will dictate the pace but must slow sufficiently to allow all karts behind to catch up and form a long train. The formation should then remain as tight as possible with no overtaking permitted (unless a kart slows dramatically or stops because of a problem).

At the end of the neutralisation, the Clerk of the Course will call for the yellow lights to be switched off. A waved green flag at the Start Line will signal the resumption of the race. Green flags will then be shown at all Marshal Posts for a maximum of 1 lap.

Drivers should remain in single file and in between the tramlines on the approach to [the green flag at] the Start Line and may accelerate only after crossing the yellow line. Overtaking remains prohibited until crossing the Start Line at the time of the green flag.

Each lap completed during the neutralisation will be counted as a racing lap. If the race finishes during the neutralisation, the karts will take the chequered flag as usual.

2.10 – RACE SUSPENSION:

Should it become necessary to suspend a Race or Practice because the circuit is blocked by an accident or because weather or other conditions make it dangerous to continue, the Clerk of the Course or the Race Director shall order a red flag to be shown at the Start Line.

Simultaneously, red flags will be shown at all Marshals' Posts. The decision to suspend the race or practice may be taken only by the Clerk of the Course (or by his deputy) or the Race Director. If the signal to stop racing is given all karts will immediately reduce their speed and come to a stop on the track at the place designated during the Briefing, considering that the classification of the Race will be the classification at the end of the lap prior to that during which the signal to stop was given.

The procedure to be followed varies according to the number of laps completed by the Race leader before the signal to stop was given:

2.10.1 – Less than 2 laps complete:

Any race stopped before the leader has completed 2 laps will be declared null and void. The race will be re-run in its entirety. All available karts will restart from their original grid positions. Front fairings may be reset without the mandatory penalty [Article 13M], but drivers are still culpable for any driving offences committed during the abandoned race.

2.10.2 – More than 2 laps but less than 75% complete:

If more than 2 laps but less than 75% of the distance scheduled for the Race has been completed by the leader (rounded up to the nearest whole higher number of laps), the Clerk of the Course shall, at his discretion, decide to:

- a) Abandon the race. Should a restart of a race not be possible, the race result shall be declared as the finishing order behind the leader on the last full lap completed by him/her and before the race was stopped. Half championship points will be awarded.
- b) Consider the race suspended and run it as a two-part race. In this case, the Race will be restarted as a single-file rolling start (in between the tramlines) with no overtaking before the start line (see Article 2.9). Resuming start positions will be determined by the finishing order at the end of the last full lap before the race was suspended. Any front fairing which is subject to a Judge of Fact report must be reset on the grid before the race is re-started. Penalties will be imposed automatically (see Article 13M) and added to the final result. The race distance shall be the number of laps required to make up the full race distance. The finishing order of the second part shall be the finishing order of the race.
Drivers "one lap down" in the first part shall be deemed to have finished the race 1 lap down unless they 'unlap' themselves.

While racing is stopped, the whole course shall be considered as Parc Fermé and no work may be carried out on any kart (except to reset the front fairing in the correct position under the supervision of the Scrutineers). No one may enter the circuit without the express permission of the Clerk of the Course.

If a kart leaves the circuit during the stoppage it will not be permitted to rejoin the race.

Only the karts that were proceeding under their own power at the time the race was stopped by the display of red flags will be allowed to take the new start.

Karts involved in the incident that gave rise to the stoppage may only rejoin the race if the Clerk of the Course, in consultation with the Chief Scrutineer, is satisfied that a kart is safe to continue without repair, and the Chief Medical Officer is satisfied that a competitor is fit to continue racing.

Exceptionally, if it becomes necessary to remove all karts from the circuit before the restart, Parc Fermé conditions apply and no work or repair may be carried out without the express consent of the Chief Steward or Clerk of the Course. This will be discretionary.

2.10.3 – More than 75% complete:

If 75% race distance or more has been completed by the leader (rounded up to the nearest whole higher number of laps), the race will be deemed to have ended. The race results shall be declared as the classification on the last full lap completed by all karts that were proceeding under their own power at the time the red flag was displayed. Karts not running at the time the red flag was displayed will be classified behind all running karts on a roll back of laps basis.

2.11 – RACE FINISHING PROCEDURES:

A. The chequered flag signal indicating the end of the Race shall be given on the Start Line as soon as the leading kart has covered either the full race distance or the greatest distance during the time scheduled for the race.

B. Should the signal indicating the end of the race be given before the leading kart completes the scheduled number of laps or before the prescribed time has elapsed, the race will be deemed to have finished when the leading kart last crossed the Line before the signal was given.

Should the signal indicating the end of the race be delayed for any reason, the Race will be deemed to have finished when, under normal circumstances, the end of the race would have been decided if there had been no delay.

C. After having received the chequered flag, all karts shall directly go to the scales (and Parc Fermé) using the normal course of the track, without any unnecessary delay, without performing doughnuts, without stopping, without giving or receiving any object whatsoever and without any help (except that of Marshals if necessary).

Any classified kart unable to reach the scales by its own means will be placed under the control of Marshals, who will supervise the movement of the kart to the scales with the assistance of the driver.

D. For a finish to be considered valid, a driver must have crossed the Finish Line seated at the wheel of his/her kart.

E. Any driver removing both hands from the steering wheel whilst travelling at considerable speed, whether in celebration or not, will be adjudged to be driving without due care and will be referred to the Stewards.

F. In the case of a dead heat on the Finish Line revealed by timekeeping, the rule for deciding between tying drivers shall be the fastest lap time recorded by each driver during the race concerned.

2.11.1 – Weighing Scales:

The official weighing scales will be situated in Parc Fermé unless otherwise stipulated by the circuit licence. The scales must undergo annual certified calibration. Additionally, 5 individual check weights totalling 100 kg should be used at each meeting to verify the accuracy of the scales.

The Chief Scrutineer will be the judge of fact in all post-race weigh-ins. If a competitor is found to be underweight, the Chief Scrutineer will issue a report to the Chief Steward based on the series of weighing measurements taken in Parc Fermé. Any final decision relating to classification in this instance will be taken by the Stewards.

Before weighing, nothing should be handed to the competitor. Neither should the competitor collect any item before passing over the scales. Competitors may only drink water AFTER having completed the weight checks.

During a [red flag] stoppage (and before a restart), competitors may consume water only with express permission from the Clerk of the Course (or the Chief Scrutineer in cases where competitors return to the servicing park). However, in race stoppage cases where the race result will be declared, competitors may only drink water AFTER completing the weight checks.

2.11.2 – Parc Fermé:

Only authorised Officials may enter Parc Fermé. No intervention of any kind is allowed there unless authorised by such Officials.

When Parc Fermé is in use, Parc Fermé regulations will also apply in the area between the finishing line and the Parc Fermé entrance.

Parc Fermé shall be sufficiently secure so that no unauthorised person can gain access to it.

Any driver returning to Parc Fermé either during or after a race (for whatever reason) must report to the scales for weight verification.

Drivers are not permitted to leave Parc Fermé until expressly permitted by the Officials.

3 – CLASSES AND ELIGIBILITY

Specific exemptions to the below limits may be granted in line with competitor safety. Such exemptions must be applied for individually and approved by the organisers under guidance from EMSO. Such exemptions could lead to ineligibility for class awards (e.g. qualification for RMC Grand Finals, etc.). Competitors take full responsibility for these consequences.

NOTE: Annual Grand Finals eligibility is determined by the specific event regulations sanctioned by the host country's ASN as well as licence restrictions imposed by the FIA during the year of the event, both of which are outside the control of UAE RMC organisers and EMSO.

3.1 – MICRO MAX:

3.1.1 – Age Limits:

Age range 8-11 yrs.

Competitors must have their 8th birthday during the year of the event (or before) and their 12th birthday after 31st December 2025.

Eligibility for Micro MAX Grand Finals 2025 seat is likely to be for drivers born after 1st January 2014 (see Article 3 note above).

3.1.2 – Weight Limit:

Minimum weight of kart + driver (in full race gear) is **105 kg**

Recommended minimum driver weight is 24kg

3.1.3 – Numbers:

Yellow plate (22cm sides) with black numbers (at least 15cm high with 2cm stroke)

Range of numbers 1 to 99. 1 is reserved for the reigning UAE RMC Micro MAX Champion only. Number requests must be confirmed by series organisers.

3.2 – MINI MAX:

3.2.1 – Age Limits:

Age range 10-13 yrs.

Competitors must be at least 10 years of age and have his/her 14th birthday after 31st December 2025. Drivers having their 10th birthday during the year of the event are eligible to compete if they have completed one full season in the Micro MAX category or equivalent.

Mini MAX Grand Finals 2025 eligibility is likely to be for drivers born between 01 January 2012 and 31 December 2015 (see Article 3 note above).

3.2.2 – Weight Limit:

Minimum weight of kart + driver (in full race gear) is **115 kg**

Recommended minimum driver weight is 32kg

3.2.3 – Numbers:

Yellow plate (22cm sides) with black numbers (at least 15cm high with 2cm stroke)

Range of numbers 100 to 199. 100 and 101 are reserved for the reigning UAE RMC Mini MAX Champion only. Number requests must be confirmed by series organisers.

3.3 – JUNIOR MAX:

3.3.1 – Age Limits:

Age range 12-15yrs

Competitors must be at least 12 years of age and have his/her 16th birthday after 31st December 2025. Drivers having their 12th birthday during the year of the event are eligible to compete if they have completed one full season in the Mini MAX category or equivalent.

Junior MAX Grand Finals 2025 eligibility is likely for drivers born between 01 January 2011 and 31 December 2013, possibly extending to date of birth in 2010 subject to international licence grade (see Article 3 note above).

3.3.2 – Weight Limit:

Minimum weight of kart + driver (in full race gear) is **145 kg**

Recommended minimum driver weight is 40kg (recommended minimum height 145cm)

3.3.3 – Numbers:

Yellow plate (22cm sides) with black numbers (at least 15cm high with 2cm stroke)

Range of numbers 200 to 299. 200 and 201 are reserved for the reigning UAE RMC Junior MAX Champion only. Number requests must be confirmed by series organisers.

3.4 – MAX:

3.4.1 – Age Limits:

Age range 14yrs+

Competitors must be at least 14 years of age. Drivers having their 14th birthday during the year of the event are eligible to compete if they have completed one full season in the Junior MAX category (or equivalent) and weigh at least 55kg.

3.4.2 – Weight Limit:

Minimum weight of kart + driver (in full race gear) is **160** kg.

3.4.3 – Numbers:

Yellow plate (22cm sides) with black numbers (at least 15cm high with 2cm stroke)

Range of numbers 300 to 399. 300 and 301 are reserved for the reigning UAE RMC MAX Champion only. Number requests must be confirmed by series organisers.

3.5 – DD2:

3.5.1 – Age Limits:

Age range 15yrs+

Exceptionally, 14 year old drivers are eligible to compete if they (1) have their 15th birthday during the year of the event, (2) weigh at least 60kg and (3) have completed at least one full season in Junior MAX or MAX categories (or equivalent) in the previous UAE RMC season.

3.5.2 – Weight Limit:

Minimum weight of kart + driver (in full race gear) is **175** kg

3.5.3 – Numbers:

Yellow plate (22cm sides) with black numbers (at least 15cm high with 2cm stroke)

Range of numbers 400 to 499. 400 and 401 are reserved for the reigning UAE RMC DD2 Champion only. Number requests must be confirmed by series organisers.

3.6 – DD2 MASTER:

3.6.1 – Age Limits:

Age range 31yrs+

Competitors must be at least 31 yrs and have their 32nd birthday before or during 2024.

3.6.2 – Weight Limit:

Minimum weight of kart + driver (in full race gear) is **175** kg

3.6.3 – Numbers:

Yellow plate (22cm sides) with black numbers (at least 15cm high with 2cm stroke)

Range of numbers 500 to 599. 500 and 501 are reserved for the reigning UAE RMC DD2 Master Champion only. Number requests must be confirmed by series organisers.

3.7 – ENGINES:

Engines as per UAE RMC Technical Regulations 2024/25.

Only engines provided by and sealed by the official UAE Rotax Distributor or one of their official appointed Service Centres are eligible for use. See also 5.2.6.

3.8 – NOVICE DRIVERS:

A competitor will be considered as a 'Novice' and must carry Novice plates until he/she has successfully completed a minimum of 3 National or Club status events and has official approval from the Clerk of the Course to remove them.

Novice drivers will be issued with an 'Event Assessment – Sign Off Card' at registration for their first event. This card must be presented to the Clerk of the Course prior to the commencement of Qualifying. If the competitor completes the event to the satisfaction of the Clerk of the Course, the Event Assessment Card will be signed and returned to the competitor for use at the future rounds of the championship. Presentation of the card to the Clerk of the Course at subsequent events is the sole responsibility of the competitor.

Competitors will be permitted to relinquish their novice plates ONLY after obtaining three signatures.

Novice drivers will occupy the rearmost grid positions in all Heat and Pre-Final races, notwithstanding his/her qualifying performance. Pre-Final classification will be carried over to the Final.

New RMC competitors with valid licence history acquired in other championships/regions/countries should apply to EMSO for clearance to run without novice plates.

The novice plate must be a 22cm square yellow sticker or yellow plastic plate (plastic plate must have rounded off corners as per CIK regulations) with a black 'X' running from corner to corner (2-3cm stroke width). It must be displayed on the rear bumper alongside the regular race number plate.

3.9 – OTHER CLASSES:

Other championships may run alongside UAE RMC Race Meetings held at Al Ain Raceway and other guest venues. Operated by AARKC, these classes will enjoy 'Club' status (not National) and will be subject to their own regulations which should be viewed separately.

4 – ORGANISER'S SUPPLEMENTARY PROVISIONS

4.1 – TYRES:

4.1.1 – Eligible Tyres:

Only the following tyres may be used (see each event Supplementary Regulations):

- MOJO C2 – Micro MAX, Mini MAX
- MOJO D2 – Junior MAX
- VEGA XH3 & XH4 – MAX
- MOJO D5 – DD2, DD2 Master

In the exceptional event that insufficient quantities of tyres are available, the organisers reserve the right to provide a suitable substitute tyre. Competitors will be notified of any such changes by means of an official Bulletin.

4.1.2 – Quantity of Tyres Permitted:

For each race event (from Practice to the end of the Final), the maximum number of slick tyres, new or used, permitted is 1 complete set (2 front, 2 rear). The organisation reserves the right to change this for specific events by means of a Supplementary Regulation.

4.1.3 – Pre-Ordering of Tyres:

New tyres should be ordered in advance by completing the relevant section of the Race Entry Form according to individual requirements. These must be paid for with the Entry Fee (see 2.4). Tyres may be available on race day but they will be subject to a premium so competitors are strongly advised to pre-order and prepay for tyres.

4.1.4 – Tyre Fitting:

The Organisers warmly encourage competitors to develop the skills needed to fit their own tyres to rims but should at all times guard against using inappropriate substances to assist this process. Tyre soap is acceptable but should be applied to the tyre beads only. Competitors are reminded that the application of tyre softeners is against the rules and evidence of this or any other substance across the tread face of a tyre will inevitably result in disqualification from the Race Meeting and further sanctions.

4.1.5 – Tyre Marking:

Each tyre, whether new or used, will be marked/scanned in advance by the Organisers. Additionally, the Chief Scrutineer will, at his discretion, mark these same tyres during Scrutineering. The markings will vary from race to race to reduce the possibility of falsification (cheating).

It is mandatory to use marked tyres during every session of the race meeting. Tyres will be scanned or checked for markings throughout the day.

It is the responsibility of the driver to ensure that he/she participates in all sessions with marked tyres. Any competitor found to be competing on tyres without the proper markings, or deemed by the Panel of Stewards to have deliberately attempted to falsify such markings in an attempt to gain an unfair advantage, will be disqualified from the race and may be disqualified from the entire event.

4.1.6 – Tyre Collection:

According to pre-orders (see 4.1.3), batched and marked tyres will be made ready for collection at the time indicated on the official race schedule for the event. Competitors should check that each tyre is marked clearly and appropriately at the time of collection.

WHEN SCRUTINEERING ON RACE DAY (RATHER THAN IN ADVANCE) IT IS THE RESPONSIBILITY OF THE COMPETITOR TO ENSURE THAT HE/SHE PRESENTS HIS/HER KART AT SCRUTINEERING WITH MARKED RACE TYRES.

4.1.7 – Tyre Replacement:

Additional tyres are not usually available throughout the meeting in accordance with 4.1.2 and 4.1.3. However, in the event of a tyre sustaining accidental damage (e.g. puncture) it must be presented for inspection to the Chief Scrutineer who will be responsible for deciding whether a replacement tyre can be issued by the organisation (see also 4.1.5). Where this is permitted, the replacement tyre must be fitted to exactly the same corner of the kart as the tyre that sustained the damage.

4.1.8 – Long-term Use:

Competitors wishing to use tyres at the following race meeting may do so by leaving them in the control of the Organisers at the end of the race meeting according to the following strict protocol **BEFORE** the trophy presentation (30 mins after the last RMC class Final):

- (1) Remove race tyres from kart and place them in a suitable tyre bag. **Note: other bags are not acceptable due to handling/storage difficulties.**
- (2) Ensure that each bag is clearly and indelibly marked on the outside with the competitor name and number.
- (3) Hand over the bagged tyres to the appropriate Al Ain Raceway representative. The organisers will not accept responsibility for any bags/tyres not handed over properly, e.g. dumped randomly near to the organisation base.

These bagged tyres/rims will be kept in controlled conditions by the Organisers, re-marked and handed back to the competitor **at the following round.**

The organisers will not store/transport tyres/rims and will not accept responsibility for these items beyond this point. Competitors unable to collect used tyres at this pre-arranged time must nominate someone else to collect them or risk them being discarded.

The administrative charge to cover tyre collection, handling, transport, storage, remarking and redistribution between race events is AED 150. This payment is non-transferable and non-refundable and **MUST** be paid along with the Race Entry Fee for the following race meeting.

Long term use is **NOT** an option for events taking place outside UAE due to the costs associated with transporting used tyres across the UAE border.

Note: During re-marking, the Organisers may employ chemical treatment detectors, e.g. tyre sniffers. If the Organisers suspect that a tyre has been treated or tampered with in any way, the tyres will be removed from use. If investigation reveals an underlying attempt to deliberately cheat, further action will be taken against the competitor or entrant in line with recommendations of the International Sporting Code through EMSO.

Because of the advance preparation required to re-mark tyres for future race meetings, this provision will NOT be available for late entries. New tyres must be purchased from the race organisation.

4.2 – FUEL:

4.2.1 – Fuel Substitution:

In the interests of consistency and fair play any competitor at any time, at the discretion of the Senior Officials, may be asked to present his/her kart with fuel tank and all fuel lines empty. Premix petrol will then be supplied to that competitor for use in that race. Petrol will be from the local supplier/pump (95-98 octane lead free).

4.2.2 – ‘Parc Fermé’ and/or ‘Control’ Fuel:

If the organisation elects to implement ‘Parc Fermé’ or ‘Control’ fuel, this will be conveyed by means of a Bulletin or Supplementary Regulation. Competitors will be required to present one clean, empty fuel container of capacity 20 litres (with race number clearly and indelibly marked on it) and race fuel tank to the organisation along with payment to cover fuel and 2T oil. Fuel containers must be in good condition, free from leaks and with caps/covers on all inlets/outlets/breathers.

4.3 – TRANSPONDER:

4.3.1 – Transponder Hire:

Transponder hire will be charged at AED 210 per weekend and transponders will be distributed at signing on. A deposit will be required at the time of hire. This may be in the form of cash/cheque to the value of AED 2000 or another acceptable item of value.

The driver/entrant is liable for the full cost of the transponder and clip (total AED 2000) in the event of any loss or damage sustained during the hire period, howsoever caused.

There are a limited number of transponders available for hire. These will be allocated as Entry Forms are received on a first-come, first-served basis.

Any entry received after all hire transponders are allocated will need to buy a transponder.

4.3.2 – Transponder Purchase:

Subject to availability, transponders may be purchased from the organisation at regular retail price. This includes charger, user manual and fixing kit. Please check in advance with the race organiser for stock availability.

4.3.3 – Transponder Fitting:

The transponder must be mounted in an approximately upright position (i.e. the “R” clip at the top) on the back of the seat.

It should be secured at a height of 25cm ±5cm. This height can be measured from the ground to any part of the transponder.

4.3.4 – Transponder Failure:

It is the driver’s responsibility to ensure that the transponder is fitted securely, and in the correct position, at all times when racing, as well as being sufficiently charged. Failure to do so may result in either loss of the transponder or intermittent (or zero) function which could lead to non-classification.

WHERE PRE-RACE DAY OFFICIAL PRACTICE IS AVAILABLE, THIS WILL INCORPORATE LIVE TRANSPONDER TESTING. ALL DRIVERS ATTENDING MUST RUN WITH THEIR REGISTERED TRANSPONDER FITTED. THIS WILL HIGHLIGHT ANY ISSUE AHEAD OF RACE DAY AND WILL REDUCE THE RISK OF NON-CLASSIFICATION.

In case a transponder failure is identified by the Officials during a race, the competitor will receive a mechanical failure flag and be expected to retire from the session.

It is not the responsibility of the Officials to monitor individual timing issues. Where such issues are not identified during the race, the final classification will remain as per the official timing system report, regardless of what circumstances led to the failure.

For point scoring purposes, competitors will be considered as having started the race.

4.4 – RECORDING EQUIPMENT:

Personal kart mounted Go Pro cameras, if permitted, should be submitted to the race administration during registration. The unit should be fully charged, labelled indelibly with the competitor’s race number and must be equipped with charging cable(s) and SD card [which will be fully formatted before use].

Cameras will be fitted on the Pre-Grid and removed in Parc Fermé.

All footage will remain the intellectual property of Al Ain Raceway. Tampering or interfering with the fitted equipment by a driver or team member is a sanctionable offence and will be referred to the Stewards and EMSO.

4.5 – FLOOR MATS:

The use of floor mats (or suitable equivalent floor covering) beneath karts when work is being carried out is mandatory throughout practice and race days. This prevents problematic, unsightly and costly tarnishing of paddock areas belonging to the host venue. The organisers reserve the right to eject from the paddock area any competitor who fails to observe this ruling and/or may insist that the offender purchase/hire appropriate floor protection if immediately available.

4.6 – ENGINE RUNNING:

Engines may be run for a maximum of 5 seconds in a designated area adjacent to the Pre-Grid, for the sole purpose of confirming positive fuel flow, immediately after installation of a fuel tank (which has been under Parc Fermé control conditions) and prior to taking up the competitor’s position on the Pre-Grid to participate in a session or race.

From the start of the race meeting (including official practice), the starting up, running in, warming up or testing of kart engines in the Paddock as well as in the Reserved Areas (see Article 20 of the International Sporting Code) is strictly prohibited. First offenders will be penalised by a fine of minimum AED 250. In the event of repeated breach, the Stewards will consider and inflict harsher penalties, including the disqualification of the driver concerned from the competition.

4.7 – PADDOCK FEES

Paddock fees are applicable to all competitors/teams operating from the main paddock area during official practice and race days at all circuits. The nominal fee is AED 5 per m² and will be charged to all participants/teams occupying an area in excess of 25m².

The charge is only applied once per race weekend (not per day).

Any non-essential vehicles should be kept outside of the main paddock so as to avoid unnecessary space being occupied and consequential charges being levied.

4.8 – EXHAUST/ISOLATING MAT

Specific rules concerning exhaust system inspection, packing and sealing will be contained within the Supplementary Regulations of each event. For classes where this is specified:

- (1) Competitors must purchase a new isolating mat through the organisation during the registration (voucher system) and then present themselves with a fully dismantled and disassembled exhaust to the scrutineers at the time stipulated on the race schedule. The exhaust must be clean.
- (2) The exhaust will be inspected by the Technical Scrutineer(s) in accordance with the UAE RMC Technical Regulations prior to assembly.
- (3) The exhaust must be fitted with this new isolation mat provided by, and in the presence of, the Technical Scrutineers.
- (4) Once checked and reassembled, the exhaust will be sealed by the Technical Scrutineers and the race number of the driver will be marked on the exhaust.

This exhaust is the only exhaust allowed to be used by the driver until the end of the event. If, during an event, the exhaust becomes damaged, at the discretion of the Chief Scrutineer the driver can exchange the exhaust for a replacement and repeat steps 1-4 above PRIOR to leaving the Parc Fermé area. The damaged exhaust will be retained by the Scrutineers.

5 - TECHNICAL REGULATIONS

5.1 – GENERAL:

The UAE RMC Technical Regulations 2024/25 also apply to the UAE RMC. Amendments may be made at anytime by AARKC in collaboration with EMSO by way of Competitor Bulletins or Event Supplementary Regulations which will be posted on the Official Notice Board at each event.

FIA Karting Regulations apply to all safety issues except where otherwise stated.

Karts are only allowed to race if they are in a condition which meets FIA Karting safety standards and if they comply with the regulations. They must be maintained in such a way as to not represent a danger to the driver or other participants/spectators.

Remember **“ANYTHING WHICH IS NOT EXPRESSLY ALLOWED IS FORBIDDEN.”**

5.2 – KARTS:

5.2.1 – Chassis:

Chassis' with CIK/FIA 2006/2009/2012/2015/2018/2021/2024 Homologation and/or approved by Al Ain Raceway (in collaboration with EMSO) will be sanctioned to race. Rotax RM1 chassis' can only be used with all original components mounted.

Drivers will be allowed only one chassis per meeting. In the exceptional case of the chassis sustaining irreparable damage during the course of the meeting (i.e. in the opinion of the Technical Scrutineer it is neither safe nor practical to repair), at the discretion of the Chief Scrutineer (in consultation with the Stewards), a replacement chassis may be used. This chassis must first be inspected and approved for use by the Scrutineers.

Front brakes are mandatory in DD2/DD2 Master but prohibited in all other classes.

5.2.2 - Bumpers and Bodywork:

Only CIK/FIA homologated bumpers and bodywork are legal to use. Side pod bars must be securely fastened. Use of the CIK front fairing mounting kit is mandatory in all classes.

It is only permitted to fix the front fairing onto the kart using the CIK front fairing mounting kit. No other device is authorised. It must be possible for the front fairing to move freely back in the direction of the chassis without any obstruction from any part that may restrict movement (Art. 2.3.3 FIA Karting General Prescriptions & Technical Drawings 2.2 & 2.2.1).

The front bumpers (upper and lower tube) must be rigidly connected with the chassis and must have a smooth surface. Any mechanical work or other intervention to maximise the friction of the front bumpers is strictly forbidden.

5.2.3 – Wet Race:

In wet weather conditions, the side bodywork must not protrude beyond the plane defined by the outer edge of the rear wheels (as per FIA Karting Technical Drawing No. 2.1.)

5.2.4 – Rims:

With the exception of the Micro MAX and Mini MAX classes wheel rims must be fitted with a minimum of three bead retaining screws.

5.2.5 - Fuel Tank:

No coverings may be placed on or around fuel tank, i.e. silver reflective foil.

5.2.6 – Engines:

Al Ain Raceway is appointed as the authorised Distributor for Rotax Kart Products in the United Arab Emirates, and is an authorised Service Centre and the only sealing authority.

Only genuine Rotax components that are specifically designed and supplied for the FR125 MAX, MAX EVO, DD2 and DD2 EVO engines are legal. These parts must be obtained from Al Ain Raceway.

Only engines which have been checked and sealed by Al Ain Raceway (GCC ROTAX Distributor) or one of their official Service Centres/Agents are allowed to be used. Any engines without a valid seal and accompanying "Rotax Engine Identity card" issued by Al Ain Raceway [or one of their appointed sealing agents] will not be permitted for use.

Any driver who is unable to present his/her Rotax Engine Identity Card during a race event when asked to do so by one of the Officials will receive a fine of AED 250. Loss of the "Rotax Engine Identity card" will necessitate a replacement and an accompanying fine of AED 500.

A maximum of TWO engines per driver per meeting will be allowed.

In exceptional cases, (e.g. engine(s) submitted at Scrutineering experience technical failure) drivers may have the option of using a third engine but this is at the discretion of Chief Scrutineer in consultation with the Stewards and the event organisers.

Engines originating from anywhere other than Al Ain Raceway will be rejected and not permitted for use. Engine seals may only be removed/replaced by Al Ain Raceway. Engines with a broken/invalid seal may not be used. In the unlikely event of a broken seal it must remain attached to the engine for inspection to be made by Al Ain Raceway.

IF AL AIN RACEWAY SUSPECTS THAT AN ENGINE HAS BEEN TAMPERED WITH, THAT ENGINE WILL BE EXCLUDED FROM COMPETITION.

5.2.7 – Ballast:

The mass of the kart may be adjusted with one or more solid blocks attached to the chassis frame, to a chassis auxiliary part (except bumpers) or the seat.

Maximum mass of a single ballast 5kg, attached by means of tools with at least two bolts of minimum diameter 6 mm (0 - 2.5kg block) or 8mm (>2.5 - 5kg block). Combined ballasts on the same attachment count as a single ballast.

Reinforcement plates (min thickness 1mm, min diameter 20mm) are mandatory for the attachment of the ballast to the seat. A competitor wishing to use a single weight in excess of 5kg must apply formally to the Chief Scrutineer during pre-race Scrutineering. He/she must present the ballast in question along with details on location and fastening method. The Chief Scrutineer will consider each application on a case-by-case basis before approving/rejecting at his sole discretion.

5.2.8 – Steering System:

The steering wheel hub should be secured to the steering column by means of a minimum of 1 high tensile bolt (minimum diameter 6mm) and corresponding nyloc nut. The bolt should be fitted such that the bolt head remains on the upper side of the steering wheel hub (when the steering wheel is in the neutral position), with the nyloc nut on the lower side. Once secure, electrical tape must be wrapped around the steering wheel hub so that both fastenings are encapsulated.

The steering column must be fixed with a safety clip system for the lower bearing restraint nut and two collars between the steering column support bracket.

5.2.9 – Chain Guard:

With the exception of DD2, a chain guard is compulsory and must be an effective protection over the top, and on both sides, of the exposed chain and sprockets, and extend to at least the lower plane of the rear axle.

5.2.10 – Seat and Supports:

The seat must be tightly fastened to the chassis seat supports at all times. Reinforcement plates (minimum thickness 1.5mm and minimum surface area 13cm² or minimum diameter 40mm) are required to support the upper part of the seat. This also applies to additional seat stays which, if used, must be tightly anchored at both ends. Seat stays must be completely removed from the chassis frame and seat if not in use.

5.3 – 'ALL ENGINES EQUAL' SUBSTITUTION SCHEME:

In the interests of promoting fair play and eliminating any murmurings of discontent, all competitors are bound to accept the 'All Engines Equal' substitution scheme.

5.3.1 – Procedure:

(1) During a race meeting, a competitor shall formally advise the Chairman of the Stewards in writing that they wish to invoke the right to 'substitute' the engine of another competitor. This signed, written statement must include all details relevant to the engine in question (including ownership thereof), together with his/her personal details for review by the Stewards. This must be submitted in person before the end of the Final race and accompanied by a **non-refundable** cash amount as listed below:

125 MAX DD2	AED 19,995	125 MINI MAX	AED 14,995
125 MAX	AED 16,995	125 MICRO MAX	AED 13,995
125 JUNIOR MAX	AED 15,995		

(2) At the conclusion of the Final race, the engine will be detained in Parc Fermé. Once the Chief Scrutineer has completed his technical checks, he will arrange for the engine to be removed from competition and passed, with its engine ID card, to Al Ain Raceway as the UAE's authorised Distributor.

For clarification, 'engine' includes all parts contained within the engine seal plus e-starter (294802), pick-up sensor (265560), clutch assembly (complete – as it finished racing, including front sprocket), clutch cover (260772), exhaust socket (273190 or equivalent), exhaust valve assembly (MAX and DD2 only, from exhaust valve 253725 to adjustment screw 241220 or equivalent).

(3) A brand new sealed engine and accompanying ID Card (with new parts as specified in (2) above), of the latest available specification, with full manufacturer's warranty, will be provided as replacement by Al Ain Raceway.

(4) The engine that was substituted will be completely disassembled and inspected by Al Ain Raceway before being removed from competition as a complete unit.

5.3.2 – Conditions:

The above procedure must be followed in full and within the correct time parameters. The engine substitution cannot be enforced before the end of the Final race. On double-header weekends the engine substitution can only be enforced on the final day.

Engine substitutions can only be enforced if the application is received from a registered competitor/Entrant of AARKC from the same class (same engine type).

A competitor may only apply for an engine substitution ONCE during the season.

5.4 – TECHNICAL CHECKING NOTES:

- A. Scrutineering shall be carried out by duly appointed officials who shall be responsible for the organisation of the servicing parks and/or Parc Fermé, and who alone are authorised to give instructions to competitors/entrants regarding technical matters. No intervention whatsoever may be carried out therein without the authorisation of these Officials.
- B. All karts are checked in accordance with UAE RMC Technical Regulations. However, if any kart is dismantled or modified in a way that could affect safety or call into question its eligibility (or which is involved in an accident with similar consequences), it must be re-presented for scrutineering approval.
- C. The Clerk of the Course may require that any kart involved in an accident be [stopped and] checked by the Scrutineers.

- D. At any time during an event, the Scrutineers may:
- (1) check the eligibility of a kart or of a competitor's equipment,
 - (2) require a kart to be disassembled by the competitor (or his/her representative) to verify that the conditions of eligibility and conformity are fully satisfied,
 - (3) Require an entrant to supply them with such parts or samples as they may deem necessary

6 - SAFETY EQUIPMENT

All safety wear (helmet, gloves, boots, race suits) must be approved under the FIA Karting Technical Regulations, Article 7.

6.1 – CRASH HELMET:

The driver must wear a helmet with efficient and unbreakable protection for the eyes.

Helmets must comply with the below standards for drivers under 15yrs:

Snell-FIA CMH (Snell-FIA CMS2007 and Snell-FIA CMR2007)

Snell-FIA CM (Snell-FIA CMS2016 and Snell-FIA CMR2016)

Helmets must comply with the below standards for drivers 15yrs +:

Snell Foundation K2015, K2020, SA2015 and SA2020

Snell-FIA CM (Snell-FIA CMS2016 and Snell-FIA CMR2016)

Snell-FIA CMH (Snell-FIA CMS2007 and Snell-FIA CMR2007)

FIA 8859-2015, FIA 8878-2024, FIA 8860-2010, FIA 8860-2018 and FIA 8860-2018-ABP

Helmets must have an efficient and unbreakable visor for the eye opening. Visors must feature the logo of the manufacturer and the production date. The addition of any device to a helmet, aerodynamic or otherwise, is allowed if it was homologated with the helmet concerned.

M6 anchorages (HANS attachment points) cannot be used for safety reasons.

Dark visors are only permitted during daylight hours. Clear visors are mandatory after sunset. It is the responsibility of the competitor to ensure that sponsor sticker requirements are adhered to.

Drivers MUST ensure that their helmets are correctly fastened at all times while driving. This is a fundamental safety matter where 'forgetfulness' could prove disastrous, and even fatal. Failing to properly secure a helmet is not acceptable. The penalty for this offence is disqualification from the race and possible expulsion from the race meeting.

Similar care should be taken to ensure that long hair is securely and permanently retained within the helmet (tied up within balaclava/liner) and loose items of clothing, lanyards, etc. are removed.

6.2 – RACE SUIT:

Fabric overalls must have either "Level 2" CIK-FIA homologation granted according to CIK-FIA standard 2013-1 or be Grade 1 or Grade 2 Karting Overalls complying with FIA Standard 8877-2022. They must cover the whole body, legs and arms.

Current FIA-homologated overalls (Standard CIK-FIA N2013-1) are accepted during their useful life, which is indicated on the label of the overalls, but not beyond 31.12.2029.

Leather overalls complying with the standards defined by the FIM are authorised. However, any competitor wearing leather overalls in UAE heat is liable to become a laughing stock and will not be helped out of the kart at the end of the race.

6.3 – GLOVES:

Gloves must be in good condition and must completely cover the hands, wrists and fingers or must comply with FIA Standard 8877-2022.

6.4 – BOOTS:

Boots must be in good condition and must cover the feet and protect the ankles or must comply with FIA Standard 8877-2022.

6.5 – KART BODY PROTECTION:

The use of karting body protection complying with FIA Standard 8870-2018, and of the correct size in relation to the driver's height – or up to one size lower – is recommended.

6.6 – FIRE EXTINGUISHER:

Competitors are required to have a fully serviceable handheld fire extinguisher (of type CO₂, foam or powder) in good condition and of minimum capacity 2kg, equipped with an unbroken [tamper] seal and locking pin. It must have a working gauge showing that the pressure is in the operable range/position and a valid service tag (provided by a licenced fire extinguisher maintenance contractor).

7 – REGULATORY AMENDMENTS

Al Ain Raceway Kart Club reserves the right to issue additional statements concerning the Rules and Regulations from time to time. All such statements will be issued to all registered competitors by way of Competitors' Bulletins at Race Meetings.

8 - ADVERTISING ON KARTS, OVERALLS AND HELMETS

Competitors will be obliged to carry official RMC stickers and sponsor logos on their karts, race suits and helmet. Any such advertising material will be provided by the Organisers along with instruction on positioning as necessary.

Competitors are responsible for the presentation and preservation of sponsor stickers/logos. The organiser will provide 1 complete set of stickers to each competitor free of charge. Lost/damaged stickers must be replaced at the expense of the competitor.

Competitors may be required to remove decals/stickers and other advertising which may conflict with the series sponsors.

Competitors may be required to take part in further promotional activities at the events or the prize giving.

Prize winners may be obliged to wear a sponsor cap, if supplied by Race Organiser, during the award presentation. All drivers receiving awards at the post-race presentation should wear their race suit (zipped up with collar fastened) and race boots. Failure to comply with the Organiser's instructions could lead to disqualification from the results/event.

9 – USE OF THE TRACK AND OVERTAKING

The descriptions below should be viewed as complementary to Article 13.

9.1 – USE OF THE TRACK:

During each on-track session, drivers may use the track only and must at all times observe the dispositions of the Code relating to driving on circuits.

The circuit is defined by the white lines on both sides of the track. For clarification, the kerbs are not part of the track. Drivers are allowed to use the whole width of the track between (and including) these white lines. If the four wheels of a kart are outside these lines, the kart is considered as having left the track.

During a race a kart alone on the track may use the full width of the said track. However, as soon as it is caught up by a kart which is either temporarily or constantly faster, the driver is not allowed to move from one side to the other or make a move sideways to prevent a legal overtaking manoeuvre when the other competitor is already alongside (see 9.2.1).

Curves, as well as the approach and exit zones thereof, may be negotiated within the limits of the track.

9.2 – OVERTAKING/DEFENDING:

9.2.1 – General:

Overtaking, according to the circumstances, may be done either on the right or on the left. However, manoeuvres liable to hinder other drivers such as premature or dangerous changes of direction, more than one change of direction, weaving on a straight or deliberate crowding of karts towards the inside or the outside of a curve (or straight), are strictly prohibited.

Such offences shall be penalised, according to the significance (and/or repetition of the offences) by penalties ranging from a fine to disqualification from the race (see also Articles 12 and 13).

In general, ONE move across the track in defence of a position between any two corners is acceptable as long as this move is not erratic. Also, it is imperative that fellow competitors are given racing room at all times.

ILLUSTRATION:

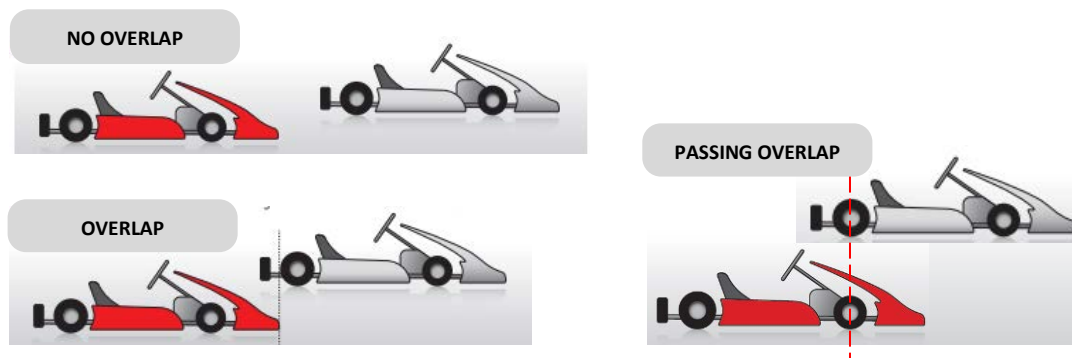

The above illustrations should aid understanding of the below points relating to overtaking.

- Where the front bumper of a kart has reached the point of being alongside (or further forward) than the rear wheel protection of another kart, 'overlap' exists.
- 'Passing overlap' is used to describe the scenario where the front wheels of a kart are in line with (or beyond) the rear wheels of another kart.

9.2.2 – Corner Approach:

Blocking is not permitted (see Article 13H). If a driver has committed to the racing line at the initial braking point of the approaching corner, he/she may not move across to block the inside line during the braking phase. He/she must not interfere with a kart trying to overtake, particularly if there is an 'overlap'.

If a driver intends to use the inside line on the approach phase to a corner in defence of a position, he/she must do so prior to the initial braking point. He/she may not subsequently move out to cover the racing line from a kart trying to overtake, particularly if there is an 'overlap'.

If a driver has a slow run out of the previous corner (for whatever reason), he/she may move across to cover the line as long as:

- i. It is safe to do so.
- ii. The move is not erratic.
- iii. Any kart with an 'overlap' is given sufficient racing room (at least one kart width to the edge of the track).

9.2.3 – Corner Entry:

If the kart making a pass on corner entry (the turn-in point) has a 'passing overlap' with another kart, then the kart being overtaken must not turn-in to the apex without allowing racing room (see also Article 13C).

In general, the onus is on the overtaking kart to execute a pass safely. Overtaking karts should not expect the kart in front to give way unless there is a 'passing overlap' at the turn-in point of the corner (see also Article 13D).

A Kart that arrives at the turn-in point with a 'passing overlap' but is considered to be out of control (e.g. smoke off the tyres, etc.) will be deemed not be in a position to make a safe pass.

9.2.4 – Corner Exit:

Racing room should also be given on the exit of a corner. Contact with the back of another kart, unsettling it on corner exit, is not permitted.

If the kart in front is 'nudged' wide and loses position this would be considered a breach and could incur a penalty (see also Article 13F).

9.3 – BEING LAPPED:

A kart alone on the track may use the full width of the track. However, as soon as it is caught by a kart which is about to lap it the driver must allow the faster driver past at the first possible opportunity. Blue flags will be used in this case to prepare the slower driver for this situation. Failure to observe the blue flags is an offence which will be referred to the Stewards.

10 – GENERAL SAFETY

- A. It is strictly forbidden for drivers to drive their karts in a direction opposite to that of the race, unless this is strictly necessary to remove the kart from a dangerous situation.
- B. During each on-track session of the Race Meeting, a kart that stops must be removed from the track as rapidly as possible in order for its presence not to constitute a danger or be an impediment for other drivers. If the driver is unable to remove the kart from a dangerous position by driving it, he/she will be required to exit the kart when it is safe to do so and remove it to a place of safety. Marshals may assist if instructed to do so by the Clerk of the Course (see 2.8.4). Except for medical or safety reasons, the driver must stay close to his/her kart until the end of the Race.
- C. If a repair area is provided, any repairs with tools are banned outside the zone. It is forbidden to take any tools and/or spare parts on board the kart. The driver can receive help only in the Repair Area determined by the Supplementary Regulations or during the Briefing.
- D. Except in cases expressly provided for by the Regulations or by the Code, no one except the driver is authorised to touch a stopped kart before reaching the scales.
- E. When the track is closed by the Race Direction after the Qualifying/Race finish (until all concerned karts, whether they are mobile or not, have arrived at the scales or at the Parc Fermé) no one is allowed to access the track, with the exception of Marshals carrying out their duties and of drivers when they are driving.
- F. A speed limit of 5mph is imposed in the pit lane at all events. Any driver deemed to be exceeding this speed limit will be liable to sanctions provided for in the Regulations. Overtaking is not permitted at any point between the pit lane entry and exit, except for the safe passing of a stationary kart.
- G. If a driver is faced with mechanical problems during any live session, he/she must evacuate the track as soon as possible for safety reasons.
- H. If a driver is involved in a collision, he/she must not leave the circuit without the Stewards' agreement.
- I. No driver may leave the Parc Fermé Area without permission from the Chief Scrutineer.
- J. The driver of any kart leaving the race shall signal this intention in good time and is responsible for ensuring that the manoeuvre is carried out safely and as near as possible to the Pit Entry.
- K. Any driver who intends to leave the track by means of the Pit Lane shall demonstrate his/her intention in due time and shall ensure that he/she does so safely.
- L. Except in cases of force majeure (accepted as such by the Stewards of the meeting), the crossing, in any direction, of the line separating the pit entry deceleration zone and the track is prohibited.
- M. In each session of the Race Meeting, drivers must at all times wear the full equipment defined under Art.6 of these Regulations (Art.7 of the FIA Karting Technical Regulations).
- N. It is forbidden to circulate with motorbikes, scooters or any other motorised devices in the Paddock. This applies to skateboards, bikes/scooters, Segways, wheelbarrows, pogo-sticks and other such equipment by extension. Space hoppers are permitted. The driving of karts in the Paddock Area is forbidden under all circumstances.
- O. In the unusual case of rain, slick tyres will continue to be used. Racing will continue as normal at the discretion of the Race Director or Clerk of the Course in collaboration with the Chairman of the Stewards. Normally, racing will only be halted if driving conditions become dangerous, e.g. in the case of standing water. It is assumed that drivers will be able to recognise wet conditions due to the appearance of rain drops on their visors.
- P. It is the Entrant's responsibility to ensure that all persons concerned by his/her Entry observes all the provisions of the Code, the Technical Regulations and the Sporting Regulations. If an Entrant is unable to be present in person at the event he/she must nominate a representative in writing. The person having charge of an entered kart during any part of an event is responsible jointly with the Entrant and/or separately for ensuring that the provisions are observed.

- Q. Entrants must ensure that their karts comply with the conditions of conformity and safety throughout the Event. The presentation of a kart for scrutineering will be deemed an implicit statement of conformity.
- R. It is imperative that, when seated in the kart, drivers are positioned so as to enable full and proper use of the steering wheel and pedals without overstretching. Further, the driver's eye-level in relation to the top of the steering wheel and Nassau Panel must permit adequate visibility straight ahead.
- S. It is forbidden for a driver (or any child) to be seated in a kart while it is balanced on a kart trolley, whether the trolley is in motion or stationary.
- T. Tail lifts are dangerous when left partially raised. Competitors and teams must ensure that vehicle tail lifts (and tail gates) in the paddock are either fully retracted or fully lowered so that they do not pose a hazard to other paddock users. Any trailer/vehicle protrusions (e.g. tow hooks) should be properly protected to avoid accidental injury.
- U. Parents are reminded of their responsibility to monitor and control their children at all times during a practice/race day. The venue (and paddock) is not a playground. Children should behave appropriately and should not be left unattended. Failure to observe this could lead to a fine or penalty being applied to the entrant or licence holder to which the offending party is linked.

11 – CODE OF CONDUCT

- A. All participants must play by the rules and respect race officials and their decisions.
- B. All participants must respect the rights, dignity and value of their fellow participants regardless of gender, ability, physical appearance, cultural background or religion.
- C. All participants must take responsibility for their actions at all times and communicate behavioural responsibilities to members of their family, team and support crew.
- D. It is the participant's responsibility to declare, prior to any participation in training, testing or racing, any medical condition or medication required that may be relevant in the event of an emergency.
- E. All participants are required to display courtesy and etiquette to other members and participants in training, testing and race events. Any disputes or problems that may arise during an event must be addressed in a respectful manner to the appropriate person (official) at the event.
- F. Drivers must take the time to read and fully understand the posted rules, regulations and conditions for any race event prior to its commencement. Requests for clarification of such regulations should be asked during the Drivers' Briefing.
- G. All participants must have respect for the environment, the hosting venue, spectators and the surrounding inhabitants. Responsibility must be taken to reduce excessive noise and keep all areas that are used as clean and presentable as possible.
- H. Drugs and alcohol are strictly prohibited during training, testing and races. Consumption of such substances during these times is a serious offence. Offenders will be disqualified from the event and face further disciplinary action.
- I. Abusive or anti-social comments on any social media platform (Facebook, Twitter etc.) or public forum are completely forbidden. This applies to competitors, teams, officials, organisers and any person associated with the series and the sport in general. Competitors are strongly advised to guard against participation in contentious, divisive and potentially damaging conversations and will be held liable for their actions.
- J. Further to 11H, social media posts relating to the UAE RMC Championship, or any element therein, must be proactive, informative or positive. Competitors, teams and associates should avoid posting negative comments about anyone other than themselves. Any party in breach of this rule is liable to bring the series and, by association, the sport into disrepute. Action will be swift on such matters and could result in expulsion from the Championship for the offender, whether individual, team, mechanic, circuit or official. In the case that the offender is not a registered competitor, action may be taken against any party associated with the offender.

12 – INCIDENTS

An “Incident” means a fact or a series of facts involving one or several drivers (or any Driver’s action reported to the Stewards by the Clerk of the Course or noted by the Stewards and reported to the Clerk of the Course for investigation), who:

- provoked the stopping of a Race
- violated these Sporting Regulations or the Code
- jumped the start or started from an incorrect position
- did not respect flag signalling
- caused one or several karts to take a false start
- caused a collision
- forced another driver out of the track
- had the front fairing on the kart in the incorrect position
- illegally prevented a legitimate passing manoeuvre by a driver
- illegally impeded another driver during a passing manoeuvre
- leaving or working on their kart in a dangerous position
- has not respected the Briefing instruction/notes
- has not respected the Race Director instructions or event notes

It will be the responsibility of the Stewards to decide if one or several Driver(s) is/are involved in an Incident; he/she/they must not leave the venue without the Stewards’ agreement.

The Stewards may use any video or electronic system likely to help them to take a decision.

The Stewards shall inflict a time or position penalty (minimum 5 seconds) on any driver having caused an incident. If the incident was caused during a Qualifying session, they shall proceed to the cancellation of the three fastest times which he/she achieved in the session concerned. However, depending on the gravity of the infringements in light of the facts, the Stewards may decide (instead of the 5-second time penalty), on a sanction among those provided for in the penalty scale of Article 12.4 of the International Sporting Code, unless the offence relates to the position of the front fairing of the kart.

Typical penalty scenarios can be seen in Article 13.

13 – PENALTY CATALOGUE

A. TRAMLINE INFRINGEMENT

TYPE A – A kart on the formation lap approaching the start line has two wheels on or outside the tram lines before the red lights are switched off to start the race (as depicted by kart number 2 in the right illustration).

Penalty: 3 seconds

TYPE B – A kart on the formation lap approaching the start line has all four wheels outside the tram lines before the red lights are switched off to start the race.

Penalty: 5 seconds

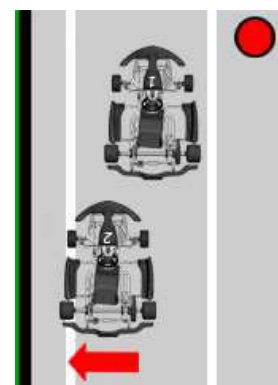

B. JUMP START

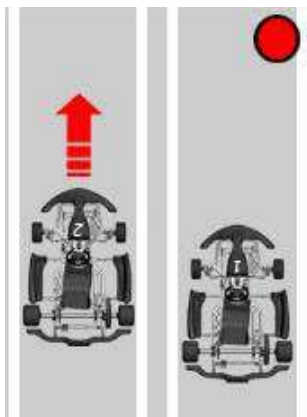

A **JUMP-START** is declared by a Judge Of Fact when a kart either (1) has accelerated prematurely before crossing the yellow acceleration line and/or before the red race start lights have been switched off, and/or (2) is ahead of its prescribed position at the time the start signal is given (as depicted by kart number 2 in the left illustration).

Penalty: 5 seconds

Note: The penalty may be applied against the offending driver(s) even if the start is aborted and declared a "FALSE START". This is at the discretion of the Clerk of the Course.

If one driver is guilty of causing multiple false starts then the race direction may apply a penalty at their discretion which could be relegation to the back or a time penalty as specified above.

C. CUTTING-IN

This is where a kart (kart number 1 in the illustration) is positioned on the outside of kart 2 and either partially/completely cuts across the racing line of, or otherwise impedes, kart 2 during a legitimate overtaking manoeuvre. This applies to the corner entry, apex and exit.

For 'cutting in' to be considered, kart 2 must be positioned so that its front wheels are at least alongside the rear wheels of kart 1 ('passing overlap' as depicted in the right illustration). Kart 2 must be under control.

An advantage is gained if (either/or):

- Kart 2 suffers a loss of position or fails to finish as a direct consequence of the manoeuvre.
- Kart 2 suffers damage which results in a loss of position or is forced to retire from the race on the same lap.
- Kart 1 maintains his/her position when he/she would have otherwise lost it.

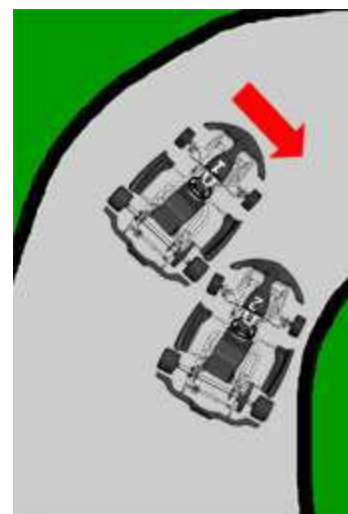

Penalty (no advantage gained): Warning/Reprimand
Penalty (advantage gained): Minimum 5 seconds

Note: The penalty shall be applied irrespective of whether there was any contact between the karts or not.

D. DIVING UP THE INSIDE

This is where a kart (kart 2 in the illustration) attempts to overtake kart 1 on the inside despite there being insufficient track space available (including the inner kerbs and areas outside the track limits) to safely complete the manoeuvre. The position of each kart relative to each other is irrelevant.

An advantage is gained if (either/or):

- Kart 2 gains a position
- Kart 1 suffers a loss of position or fails to finish as a direct consequence of the manoeuvre.
- Kart 1 suffers damage resulting in (a) loss of position(s) or is forced to retire from the race on the same lap.

Penalty (no advantage gained): Warning/Reprimand
Penalty (advantage gained): Minimum 5 seconds

Note: The penalty shall be applied irrespective of whether there was any contact between the karts or not and regardless of whether the overtaking manoeuvre was completed or not.



E. CROWDING, PUSHING or SQUEEZING

This is where one kart (kart 1 in the right illustration) forces kart 2 wide and partially/completely beyond the track limits.

The proviso is that kart 2 is positioned so that its front wheels are at least alongside the rear wheels of kart 1 (as depicted in the illustration).

An advantage is gained if (either/or):

- Kart 1 maintains his/her position when he/she would have otherwise lost it.
- Kart 2 suffers a loss of position or fails to finish as a direct consequence of the manoeuvre.
- Kart 2 suffers damage resulting in (a) loss of position(s) or is forced to retire from the race on the same lap.

Penalty (no advantage gained): Warning/Reprimand
Penalty (advantage gained) Minimum 5 seconds

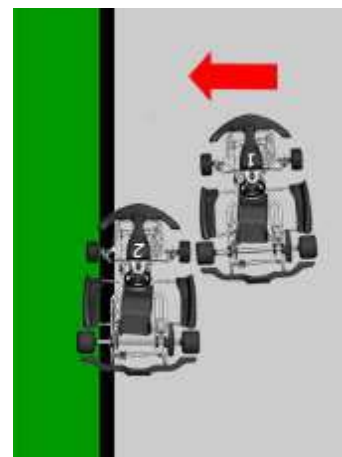

F. BUMPING or CONTACT

This is where one kart (kart 2 in the right illustration) causes avoidable contact with another kart (involving either front to rear or side-to-side impact).

Only the consequences of the impact are relevant in judging whether an advantage has been gained or not. The severity of the impact is largely inconsequential.

An advantage is gained if (either/or):

- Kart 2 gains a position and the previous order is not restored voluntarily during the same lap.
- Kart 1 suffers a loss of position or fails to finish as a direct result of the contact.
- Kart 1 suffers damage resulting in (a) loss of position(s) or is forced to retire from the race on the same lap.

Penalty (no advantage gained): Warning/Reprimand
Penalty (advantage gained) Minimum 5 seconds

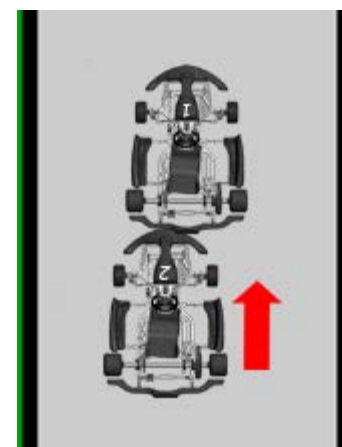

G. SHORT-CUTTING OR EXCEEDING CIRCUIT LIMITS

This is where one kart (kart 2 in the right illustration) exceeds the track limits completely and returns to the racing surface at a different point further along the track either via a shorter distance or with greater speed as a result of the breach (e.g. utilising run-off areas to gain time).

The reasons for leaving the track are irrelevant.

An advantage is gained if (either/or):

- Kart 2 gains a position and/or time which cannot be redressed during the same lap.
- Kart 2 maintains his/her position when he/she would have otherwise lost it.
- Another kart is impeded or otherwise handicapped by a kart re-joining the circuit after exceeding the track limits.
- Another kart suffers (a) loss of position(s) or is forced to retire from the race as a direct result of the re-entry of a kart which has exceeded the track limits.

Penalty (no advantage gained): Warning/Reprimand
Penalty (advantage gained) Minimum 5 seconds



Failure to complete a full lap of the circuit (as per homologated circuit map) through shortcut could lead to the lap being deleted. The Senior Officials will judge each case independently.

H. WEAVING or BLOCKING

This is where a kart (kart 1 in the right illustration) changes its lateral position / racing line on a straight by more than a kart's width, twice or more.

The distance between the karts involved and whether the chasing kart would have been able to complete an overtaking manoeuvre is irrelevant.

An advantage is gained if (either/or):

- Kart 1 maintains his/her position when he/she would have otherwise lost it.
- Kart 1 performs such a manoeuvre more than once during the same race.

Penalty (no advantage gained): Warning/Reprimand
Penalty (advantage gained) Minimum 5 seconds

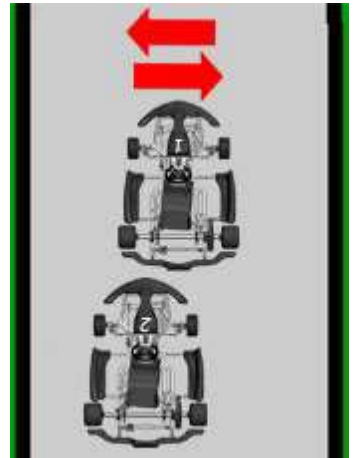

I. TECHNICAL INFRINGEMENT

This occurs when a kart and/or engine does not meet the stipulated technical regulations or specifications.

It is irrelevant if the technical infringement was discovered before, during or after a qualifying session or a race, and whether the technical infringement would have led to any advantage being gained.

Only the condition and specification of the kart / engine at the time of the official examination will be considered.

Typical examples of a technical infringement might include:

- Being underweight
- Using incorrect fuel, oil, coolant etc.
- Using modified parts
- Use of unmarked tyres.

Penalty: Disqualification
Optional: Last place classification (see below text)



In the case of a mechanical failure (technical non-conformity) occurring during the race but only being identified at post-race scrutineering after the concerned competitor has taken the chequered flag [when, in normal circumstances, a black flag with orange disc would have been displayed to the competitor during the race], the Stewards, upon receiving advice from the Chief Scrutineer, can elect to impose a penalty of last place in the classification, rather than disqualification.

This is representative of the result if a black flag with orange disc had been issued to the competitor during the normal course of the race.

The recommended penalty adjustment rests with the Chief Scrutineer in his/her capacity as Judge of Fact and is dependent on the type of non-conformity and the circumstances surrounding the non-displaying of a black flag with orange disc.

In case of a protest against the eligibility of another competitor or their equipment, such a protest must be lodged within 30 minutes of the alleged ineligibility becoming apparent.

J. FORMATION LAP OFFENCES

- (i) A kart on the formation lap improves its starting position after having crossed the red formation line and before the start signal is given (as depicted by kart number 2 in the right illustration).

Penalty: 10 seconds

- (ii) A kart on the formation lap attempts to make up time or positions by taking a short-cut (any course other than the track used during the race) to regain its original position (see Article 2.8.3).

Penalty: Black flag

- (iii) A driver fails to remove his/her kart to a safe position in a timely manner after stopping on the formation lap and being unable to continue (see Article 2.8.3).

Penalty: Grid penalty in future race

Please note that in the case of (iii) above, this applies also to racing laps

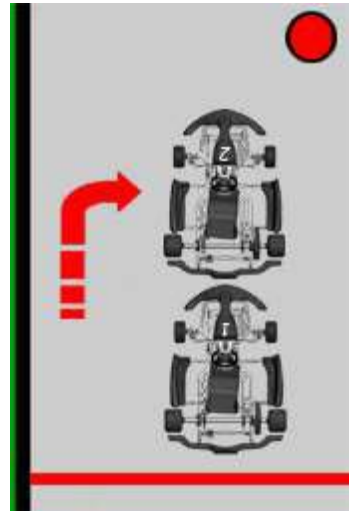

K. IGNORING FLAG SIGNALS

This is self-explanatory and is when a driver fails to observe the requirements of a particular flag being displayed by race officials.

The type of flag and the reason(s) why the flag was not obeyed is irrelevant along with whether any advantage was gained or not.

Typical examples of ignoring flag signals might include:

- Overtaking under a yellow flag (as depicted by kart number 2 in the right illustration).
- Continuing to race after receiving a black/orange or black flag or red flag.
- Failing to comply with the blue flag requirements when being lapped.

Penalty: Minimum 5s up to Disqualification

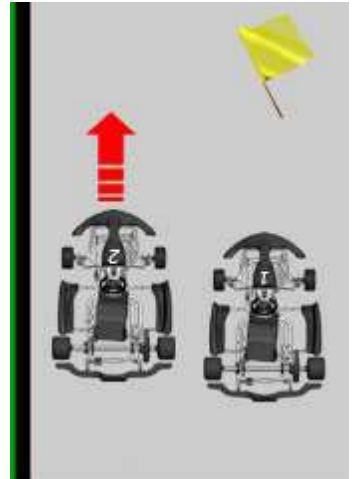

L. CAUSING A COLLISION

This is where one kart, regardless of its position on or off the track, and regardless of the proximity (or not) of other karts, and regardless of whether or not any contact occurred, is deemed to have been responsible for causing a collision.

Only the consequences of the incident are relevant in judging whether an advantage has been gained or not.

An advantage is gained if (either/or):

- The driver gains time or (a) position(s) and the previous order is not restored during the same lap.
- Another driver(s) suffers a loss of time or position or fails to finish as a direct result of the incident.

Penalty Minimum 5 seconds



M. FRONT FAIRING MOUNTING KIT

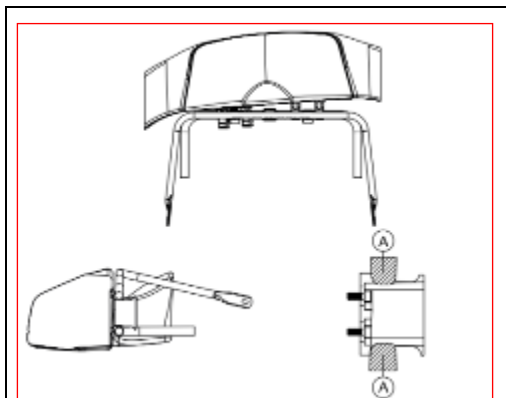

THE FRONT FAIRING IS NOT IN AN ACCEPTABLE POSITION IF ANY PART OF THE TUBES OF THE FRONT BUMPER ARE IN THE AREA 'A'.

Where the CIK-homologated detachable front fairing mounting kit is used, it must at all times during live sessions be fitted and maintained in the correct position in accordance with Article 2.3.3 of the FIA Karting General Prescriptions and Technical Drawing 2.2 and 2.2.1.

TYPE A – DETACHMENT – A Judge of Fact reports the front fairing of a kart to be in an unacceptable position as shown in the left illustration

Penalty (Race): 5 seconds

Penalty (Qualifying): Deletion of fastest lap

Note: This decision is not subject to appeal. The Competitors concerned shall not be invited to sign the decision documents.

Drivers may be referred to the Stewards for offences that gave rise to the non-compliance.

TYPE B – ILLEGAL REPLACEMENT – At any time during any live session, from Pre-Grid until post-race weighing of the kart, it is found that a Driver (or third party) has attempted to refit or has successfully refitted a front fairing that was not correctly positioned.

Penalty: Disqualification from the Competition

Note: This decision is not subject to appeal.

NOTE:

The above examples provide A GUIDE as to how penalties are applied to competitors for specific offences. However, each incident must, by necessity, be judged on its own merits and additional penalties may be applied by the Senior Officials as they deem fit, with harsher penalties likely for repeat offenders.

Where appropriate penalties cannot be applied to the session/race in which the offence occurs the Senior Officials reserve the right, at their sole discretion, to carry forward a representative penalty to the driver's next session, race or event. This may involve invoking grid place penalties or alternative sanctions as circumstances dictate, including the deduction of Championship points.

Where it is established that Competitor A has been disadvantaged as a direct result of the actions of Competitor B, the Senior Officials may look to redress the disadvantage by penalising Competitor B such that [as a minimum] he/she finishes behind Competitor A in the final race classification, even if such a penalty is outside the guidelines given above.

In all cases, the Clerk of Course / Stewards will formally notify the driver of the offence, the resulting penalty decision and the intention to carry forward the penalty to his/her next session, race or event [of the same series].

Any driver/entrant refusing to sign a legitimate penalty notice may forfeit all Championship points gained during the event and may be subject to further sanctions.

Conduct will be monitored throughout the Championship and offences recorded. Persistent misconduct is likely to result in the additional deduction of Championship points.

Terminology that may be used when referring to driving standards:

Careless Driving – departing from the standard of a competent driver.

Reckless Driving – any unintentional action by a driver which creates serious risk to others.

Dangerous Driving – any intentional action by a driver which creates serious risk to others.

SUMMARY OF PENALTIES

ARTICLE	OFFENCE	RECOMMENDED PENALTY
13A	2 WHEELS OUTSIDE TRAMLINES BEFORE START SIGNAL	3 s ADDED TO RACE TIME
	4 WHEELS OUTSIDE TRAMLINES BEFORE START SIGNAL	5 s ADDED TO RACE TIME
13B	JUMP START	5 s ADDED TO RACE TIME
13C	CUTTING IN - NO ADVANTAGE GAINED	WARNING OR REPRIMAND
	CUTTING IN - ADVANTAGE GAINED	MINIMUM 5 SECONDS
13D	DIVING UP THE INSIDE - NO ADVANTAGE GAINED	WARNING OR REPRIMAND
	DIVING UP THE INSIDE - ADVANTAGE GAINED	MINIMUM 5 SECONDS
13E	CROWDING, PUSHING, SQUEEZING - NO ADVANTAGE GAINED	WARNING OR REPRIMAND
	CROWDING, PUSHING, SQUEEZING - ADVANTAGE GAINED	MINIMUM 5 SECONDS
13F	BUMPING CONTACT - NO ADVANTAGE GAINED	WARNING OR REPRIMAND
	BUMPING CONTACT - ADVANTAGE GAINED	MINIMUM 5 SECONDS
13G	EXCEEDING CIRCUIT LIMITS - NO ADVANTAGE GAINED	WARNING OR REPRIMAND
	EXCEEDING CIRCUIT LIMITS - ADVANTAGE GAINED	MINIMUM 5 SECONDS
13H	WEAVING/BLOCKING - NO ADVANTAGE GAINED	WARNING OR REPRIMAND
	WEAVING/BLOCKING - ADVANTAGE GAINED	MINIMUM 5 SECONDS
13I	TECHNICAL INFRINGEMENT	DISQUALIFICATION
	TECHNICAL INFRINGEMENT – CHIEF SCRUTINEER DISCRETION	LAST PLACE CLASSIFICATION
13J	FORMATION LAP - GAINING POSITION AFTER RED LINE	10 s ADDED TO RACE TIME
	FORMATION LAP - TAKING A SHORT-CUT	DISQUALIFICATION
	FORMATION LAP - LEAVING KART IN DANGEROUS POSITION	GRID PENALTY IN FUTURE RACE
13K	IGNORING FLAG SIGNALS	MINIMUM 5 SECONDS UP TO DISQUALIFICATION
13L	CAUSING A COLLISION	MINIMUM 5 SECONDS
13M	FRONT FAIRING MOUNTING KIT – DETACHED	5 s OR DELETION OF LAPTIME
	FRONT FAIRING MOUNTING KIT – ILLEGAL REPLACEMENT	EVENT DISQUALIFICATION

NOTE THAT FOR OFFENCES COMMITTED DURING COMPETITIVE QUALIFYING SESSIONS , THE OFFICIALS MAY ALSO ELECT TO DISQUALIFY THE OFFENDER'S FASTEST LAP TIME(S) OR INVOKE A GRID PENALTY IN (A) FUTURE RACE(S).

14 – JUDICIAL MATTERS

14.1 – STEWARDS HEARINGS:

In hearings, competitors under the age of 18 years must always be accompanied by their parent/guardian or the duly nominated team representative who must be in possession of a valid Entrant licence. However, the parent/guardian is only permitted to act as an observer of the proceedings. Parents and guardians can only assist a Junior Competitor in presenting his/her evidence as a mentor but must not indulge in advocacy.

For the purpose of this regulation, advocacy is defined as being "*the act of arguing in favour of, or supporting*" a Junior Competitor.

Competitors over the age of 18 do not have the right to be accompanied by a team representative, parent or other representative, unless that person has been called by the Stewards and is acting as a bona fide witness.

Where the Stewards of the Meeting are satisfied with the evidence presented, and for decisions issued before the relevant end of session signal is shown imposing time or place penalties only, no formal hearing is required.

14.2 – RESPONSIBILITY FOR OFFENCES:

In accordance with FIA regulations, a Competitor will be responsible for all acts or omissions by any Participant associated with their entry at the event, and each of these will be equally responsible for any breach of these Regulations.

14.3 – WRITTEN WARNING OR REPRIMAND

Notwithstanding the imposition of any other penalties, a formal reprimand may be issued by the Stewards for a breach of a Regulation that has not significantly advantaged or disadvantaged another Competitor, but in circumstances where the offender should have known better.

The issuance of a Reprimand to a Competitor will be recorded against the Licence Holder by the Stewards in a championship log.

A Competitor with three (3) or more Reprimands recorded within a twelve (12) month period, will be required to attend a Disciplinary Hearing.

The Disciplinary Hearing shall only consider the accumulation of three (3) or more Reprimands for the purposes of imposing an additional penalty and shall not reconsider the offences which resulted in the Reprimands being issued.

14.4 – POINTS PENALTIES

A penalty resulting in a loss of points imposed upon a Competitor, shall only affect the points allocated to that Competitor's finishing position in the applicable Competition. This deduction of points shall also be applied to any overall Championship or Series point score.

A deduction of points from a Competitor does not affect the finishing positions or points allocation of any other Competitor in the Competition or Championship.

An automatic Disqualification does not prevent the imposition of any additional penalty for the same offence.

A penalty of Disqualification does not prevent the Stewards from referring the matter to a Disciplinary Hearing for the consideration of imposing a further penalty or penalties.

A penalty of Disqualification from an Event may be appealed in accordance with the Regulations; however this shall not alter the immediate application and effect of the penalty.

14.5 – JUDGES OF FACT

The Judges of Fact at each race event shall normally be the Starter, Chief Timekeeper, Scale Marshal, Barcode Officials, Grid Marshal and Chief Scrutineer.

Any other appointed Judges of Fact will be specified in the Supplementary Regulations or Competitor Bulletins.

The duty of a Judge of Fact is to decide when or whether a Kart or Driver:

- Has touched or passed a given line; or
- Exceeded a maximum limit; or
- Not conformed to a given specification; or
- Not complied with some other fact as laid down in these Regulations.

A Protest cannot be made against the decision of a Judge of Fact.

14.6 – PROTESTS

14.6.1 – The Right to Protest:

The right to protest lies only with a Competitor. Several Competitors cannot lodge a joint protest. A Competitor wishing to protest against more than one fellow Competitor must lodge as many protests as there are Competitors involved in the action concerned.

14.6.2 – Subject of a Protest:

A protest can be filed against:

- (1) Any alleged error, irregularity or breach of the regulations occurring during a Competition
- (2) The alleged non-compliance of karts with the regulations, or
- (3) The Classification established at the end of the Competition

14.6.3 – Lodging of a Protest:

Protests arising out of a Competition shall be addressed to the Chairperson of the Stewards.

Any protest shall be in writing and must specify:

- the relevant regulations,
- the concerns of the protesting party, and
- against whom the protest is lodged, when relevant.

The protest must be presented [in writing] to the Clerk of the Course or to his deputy within 10 minutes after the first posting of the provisional results of the Qualifying Practice, Heats and Pre-Final; and within 30 minutes after the first posting of the provisional classification of the Final.

In the absence of the Clerk of the Course or of his deputy, the protest shall be presented to the Stewards of the Competition [or to one of them].

Receipt of the protest shall be acknowledged in writing, with the time of receipt noted.

Where multiple Competitors are concerned, a separate protest must be filed against each Competitor. Where multiple vehicles of the same Competitor are concerned, a separate protest must be filed for each vehicle.

In principle, a protest against the eligibility of a competitor, team or a vehicle (kart) entered, must be made before the start of the official practice and, in all cases, within 30 minutes of the time laid down for conclusion of the relevant scrutineering session.

When the reason for the alleged ineligibility is not apparent, but it is alleged that the kart is performing in a manner which suggests that it is ineligible (or if (a) part(s) may have been changed after scrutineering), a protest must be made within 30 minutes of the performance that gives rise to the protest.

14.6.4 – Protest Fees:

Unless stated otherwise in the event Supplementary Regulations, the protest must be accompanied by a cash deposit of:

- AED 7500 for protests referring to the alleged non-compliance of vehicles (karts) with the regulations
- AED 2500 for all other protests

The deposit may only be returned if the protest is upheld, unless fairness requires otherwise.

In the case of protests referring to the alleged non-compliance of karts with the regulations and requiring the dismantling and re-assembly of clearly defined parts, an additional deposit may be specified by the Stewards based on a proposal by the Chief Scrutineer. This additional deposit must be paid by the protester within one hour upon receiving notification from the Stewards. Otherwise, the protest will be deemed inadmissible.

14.6.5 – Protest Hearing:

[See also Article 14.1] The hearing of the protester and of all parties concerned by the protest shall take place as soon as possible after the protest has been lodged. The parties concerned shall be summoned to appear at the hearing, and may be accompanied by witnesses.

In the absence of any party concerned or of their witnesses, judgement may be made by default.

If judgement cannot be given immediately after the hearing of the parties concerned, they must be advised of the place and time at which the decision will be given.

14.6.6 – Inadmissible Protest:

Protests against decisions made by any Judges of Fact in the exercise of their duties will not be admitted (see Article 14.5).

A single protest against more than one Competitor will not be accepted.

A protest lodged jointly by several Competitors will not be accepted.

Time penalties imposed by the Panel of Stewards for infringements of the Regulations are not susceptible to protest or appeal.

14.6.7 – Publication of Awards & Prize Giving:

In the event of any protest being lodged whose outcome might modify the classification of the competition, the Organisers shall only publish a provisional classification.

In the case of a protest affecting only part of the classification, such part as is not affected by the protest may be published definitively, and the corresponding prizes distributed.

In the case that the final decision concerning the protest is unable to be reached within a reasonable timeframe, the Organisers reserve the right to proceed with the *temporary* distribution of awards according to the provisional classification. If it is possible that the outcome of the protest could modify the classification of the prize-winners, the awards will be retained by the organisers pending the final classifications.

14.6.8 – Protest Without Foundation:

If the protest is rejected or if it is withdrawn after being brought, no part of the deposit shall be returned.

If judged partially founded, the deposit may be returned in part, and in its entirety if the protest is upheld.

Moreover, if it is proved that the author of the protest has acted in bad faith, the Stewards may inflict upon them one of the penalties laid down in the ISC.

14.7 – APPEALS

Neither the decision for imposing any penalty nor the penalty itself is eligible for appeal.

In respect of the final(s), the Stewards of the Meeting may hear a validly lodged appeal where permitted against sporting matters determined by the Clerk of the Course. However, there is no right of appeal to the National Court against any sporting decision of the Stewards of the Meeting or against any eligibility Decision.

14.8 – RIGHT OF REVIEW

14.8.1 – A party has the right to request the review of a decision if a significant and relevant new element is discovered which was unavailable to the parties seeking the review at the time of the decision concerned.

The Clerk of the Course or the Stewards who have given a ruling or, failing this, a person or body designated for the purpose ('the Review Body') may decide to re-examine their decision following a written request for review by any one of the parties concerned, being a party that is directly affected by the decision handed down.

The Clerk of the Course or the Stewards also have the right, of their own volition, to instigate such a review if they themselves discover a significant and relevant new element which was unavailable to them at the time of the decision concerned.

The Review Body must meet (in person or by other means) on a date determined at its discretion, summoning the party or parties concerned to hear any relevant explanations and, in the Review Body's judicial discretion, to consider any evidence not previously available and so to judge on the matter in the light of the facts and elements brought before them.

14.8.2 – The party or parties concerned may waive their right to a hearing in writing but shall be permitted to make written representations. A party is not entitled to be represented at any hearing.

14.8.3 – Pending determination by the Review Body, a review has no suspensive effect on the execution of the original decision of the Clerk of the Course or the Stewards.

14.8.4 – The Review Body shall have the sole discretion to determine if a significant and relevant new element exists and, if so, to determine if the original decision including any penalty shall stand or be set aside or varied. The decision of the Review Body as to whether or not such an element exists is not subject to appeal before any further judicial body.

14.8.5 – If the Review Body determines that a significant and relevant new element does exist and therefore progresses to a re-examination of their original decision, the subsequent decision of the Review Body as to whether the original decision shall stand or be set aside or varied may not be appealed.

In the event that the original decision is set aside or varied such that it affects the results of the Competition concerned, those results shall be amended accordingly even if they have previously been declared to be Final.

14.8.6 – The period during which a request for review may be brought expires at the end of the day (midnight) of the Competition concerned, except for the final round of the Championship where such requests must be received within 30 minutes of the original decision being posted (or for right of review of an amended classification, within 30 minutes of the amendment being published).

